



 **BEKAERT**

better together

## **Bekaert Agriculture Fencing**

### **Fencing for Life**

Quality Construction + Made in the USA + Trusted Expertise

## Fencing for Life

Designing and manufacturing agricultural fencing since 1880, we've learned there's no such thing as a one-size-fits-all approach. That's why we focus on delivering dynamic solutions that can be customized to fit your specific needs, and pride ourselves on manufacturing fences that are ready for a lifetime of challenges. Because **Fencing for Life** means fencing you can count on, from one generation to the next.

## Table of Contents

Why is tensile important?	<b>4</b>
Coating	<b>6</b>
Knots	<b>8</b>
Design	<b>10</b>
<b>Fencing products</b>	
Barbed Wire	<b>12</b>
Field Fence	<b>16</b>
Non-Climb Fencing and Sheep/Goat Fence	<b>20</b>
Fixed Knot	<b>24</b>
Smooth Wire Fence/Electric Fence Wire	<b>32</b>
Accessories	<b>36</b>
Fence Calculation Guide	<b>41</b>
Bekaert Fencing System	<b>42</b>
About Bekaert	<b>44</b>
Glossary	<b>45</b>

## Why is tensile strength important?

Higher tensile has higher breaking strength, which means less sag and stretch over time. It also requires less maintenance and lasts longer. Permanent stretching (elongation) of wire typically occurs at approximately 70% of the breaking strength. Bekaert high tensile solutions have a much higher breaking strength and offer greater resistance to stretching over low-carbon wires.

**For the best fit - consider your tensile, coating and knot requirements.**

**Professional Strength:** Cattleman® Pro, Gaucho® Pro, and Solidlock® Pro high-tensile solutions are the strongest fences you can buy, period. With a superior breaking strength that's up to 60 percent greater than standard low-carbon fencing, it's the go-to solution for professional installers, farmers and ranchers.

- Highest breaking strength
- Lowest total cost of ownership
- Least sag and stretch
- Fewer repairs and less maintenance
- High tensile wire

**High Strength:** Choose Gaucho® or Solidlock® if you're looking for the perfect blend of quality and value that you can count on year after year. Our high-strength high tensile products won't sag or stretch over time and require little to no maintenance.

- High breaking strength
- High value
- Less sag and stretch than traditional fencing
- Low maintenance
- High tensile wire

**Standard Strength:** Bekaert Classic fencing is the perfect choice when you just need a fence, but not just any fence will do. These low-carbon wire solutions are strong and dependable enough to carry the Bekaert name.

- Easy to work with
- Some sag and stretch over time
- Low-carbon wire

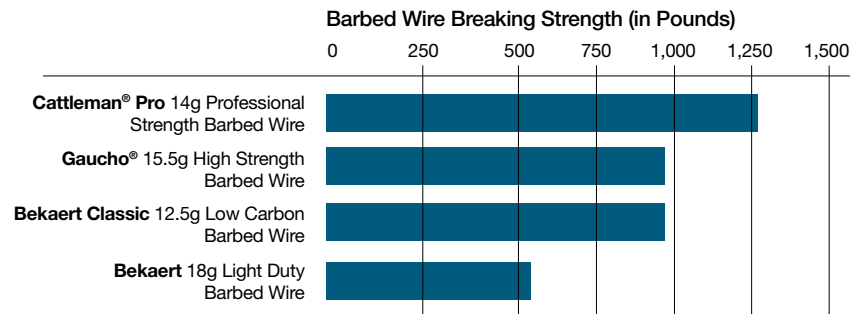
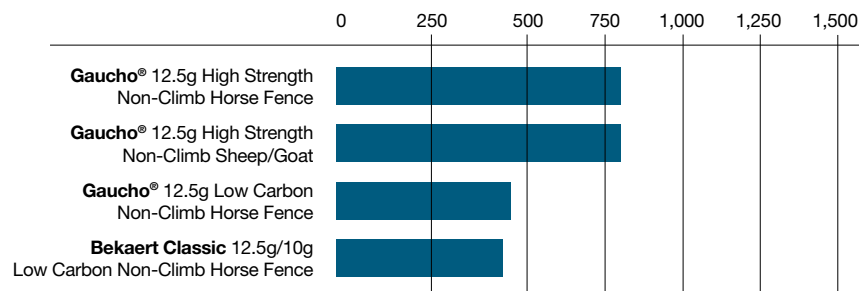
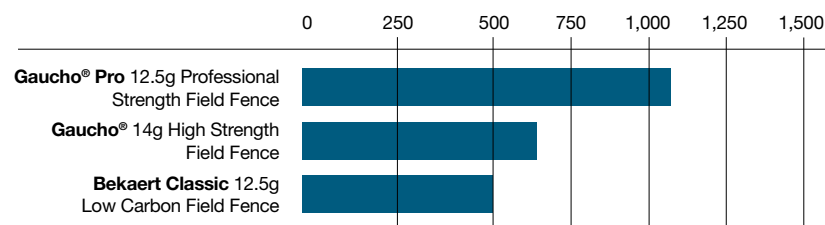
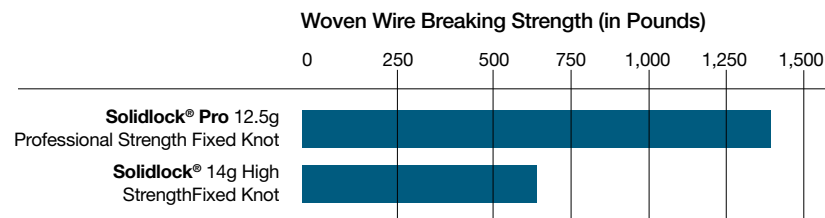

# The Right Protection

Sand, salt, chemicals and the perils of Mother Nature can all drastically reduce the lifetime of your fence. But, the right coating can make the best fence even better. You can protect your investment with peace of mind. Our exclusive Bezinal® and Class 3 coatings are backed by industry-first limited guarantees of up to 40 years.

Bezinal®+ UV Resistant Paint products all meet or exceed ASTM A 856 standards. Class 3 and Class 1 products all meet or exceed ASTM A 121, and A 116, and A 641 standards. Class 1 galvanized coating ASTM standards require .28 oz/ft<sup>2</sup> for 12.5 gauge wire.

## Bezinal®+ UV Resistant Paint

- Designed, developed and produced exclusively by Bekaert
- Advanced hybrid zinc-aluminum coating
- Superior hybrid coating with added top coat of UV resistant paint for an attractive green or black finish that guards against rust
- Outperforms galvanized coatings by at least 4 to1 (for the same coating weight)



Coatings on Gaucho® 40 and Solidlock® 40 products are guaranteed to last **at least 40 years**

## Bezinal®

- Designed, developed and produced exclusively by Bekaert
- Advanced hybrid zinc-aluminum coating
- Outperforms galvanized coatings by at least 3 to1 (for the same coating weight)



Coatings on Gaucho® 30 and Solidlock® 30 products are guaranteed to last **at least 30 years**

## Class 3

- Galvanized coating approximately three times thicker than the industry standard



Coatings on Gaucho® 20 and Solidlock 20 products are guaranteed to last **at least 20 years**

## Commercial and Class 1

- Basic galvanized option suitable for traditional fencing
- Commercial galvanized features zinc coating only, with no minimum standard or coating amount

Register your fence, submit a claim or learn more about our limited guarantees at [fencing.bekaert.com](http://fencing.bekaert.com)

# The Right Knowledge

# KNOTS

Different knots are more effective than others for certain applications. From professional grade to animal-friendly, find out which knot option is right for your job.



## Barbed wire

Featuring two strands of twisted wire with barbs at predetermined distances, Bekaert employs a design that alternates the direction of these two lines to reduce sagging and simplify installation.



## Fixed knot

The top choice for professional installers, fixed knots utilize vertical stay wires, along with an additional piece wrapped around the line, and stay wires for superior vertical strength that allows for increased post spacing and greater resistance to animal impact.



## Hinge joint knot

Common in agricultural fencing, the hinge joint is formed by wrapping vertical stay wire pieces around the line wire at each intersection. It's the economical choice that's built to absorb animal impact without damage.



## S-Knot

S-Knot is a preferred fence choice for horses. Equally spaced horizontal line wires and continuous length vertical stay wires are held in place by a forged S-Knot. S-Knot is smooth to the touch for an animal-safe finish that's strong enough to resist impact.

# The Right Knowledge

# DESIGN

Woven wire is available in a variety of heights and configurations. All Bekaert fencing features a design number that helps you better understand the product specifications.

## How to read the Bekaert fence design number

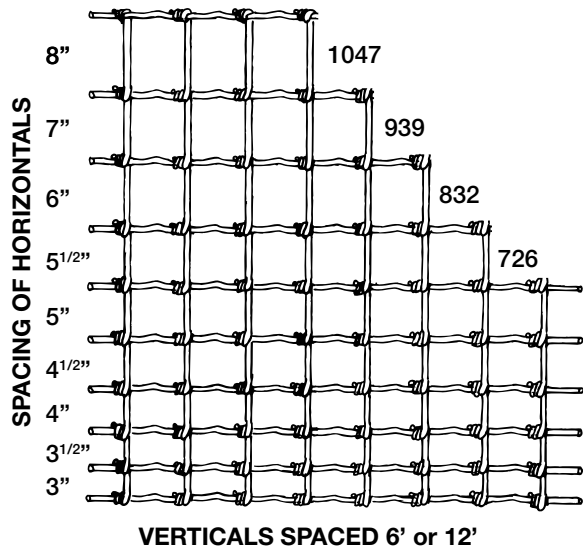

1047-6 12.5g 330' Class 3

- 10 = number of line wires
- 47 = height of fence in inches
- 6 = stay wire spacing in inches
- 12.5g = diameter of wire
- 330' = length of fence
- Class 3 = weight of galvanization

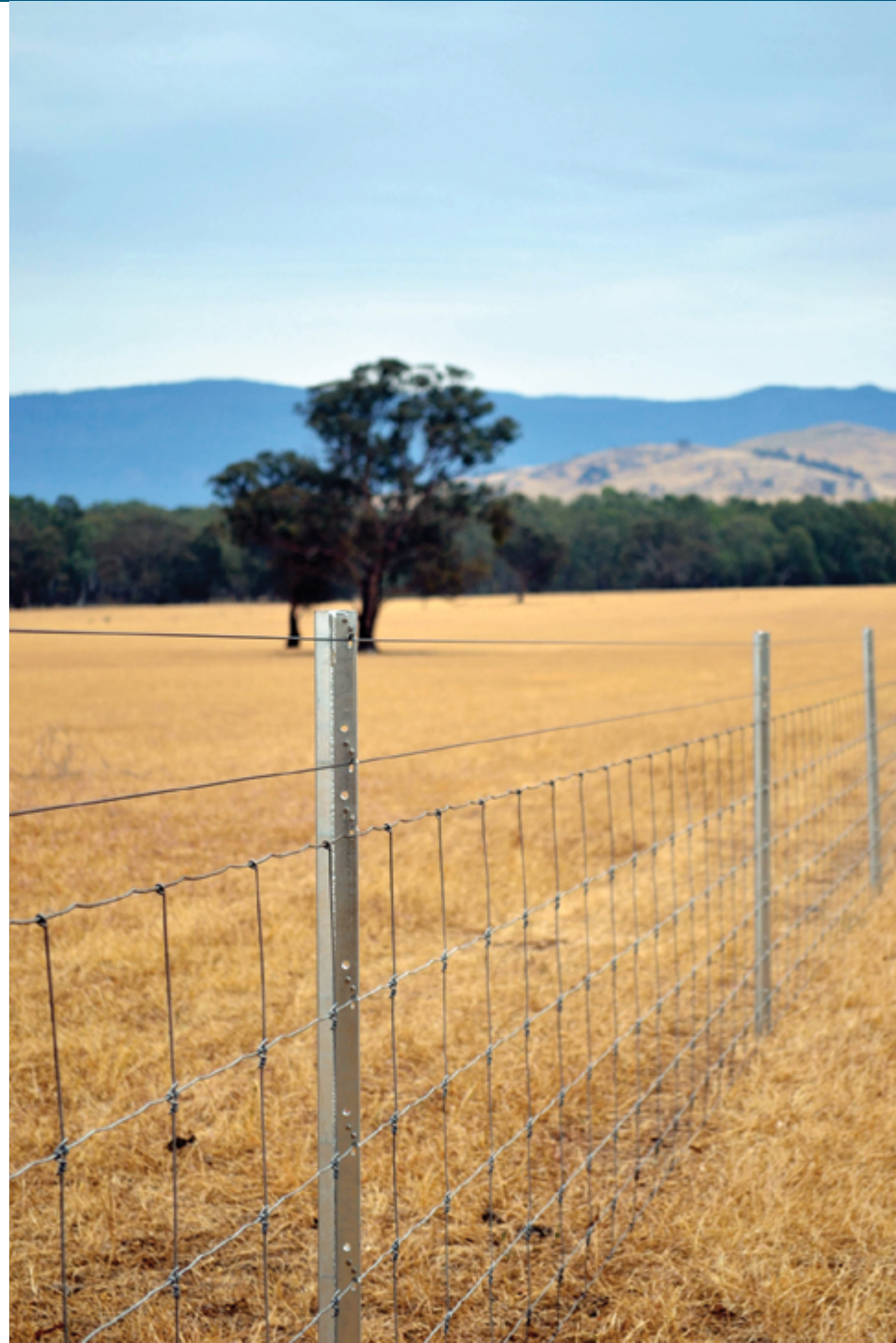

# Barbed Wire

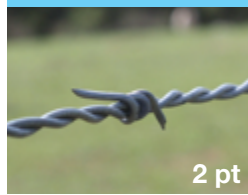
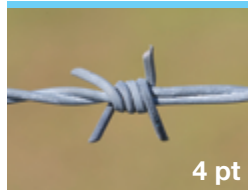

## Benefits

- adds security to existing fence systems
- sharp points for effective fencing
- two-strand reverse-twist design

## Barbed Wire Breaking Strength (in pounds)

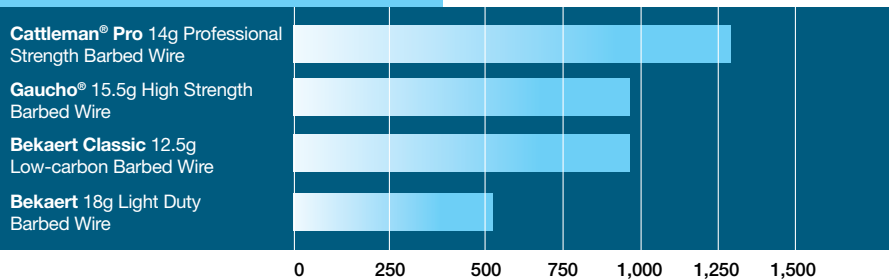

## Good for:



- ○ ○ Excellent for the job
- ○ Good for the job
- OK for the job
- Not recommended

Barbed wire					
Applications and Coatings Chart		Cattleman® Pro Professional Strength (high tensile)	Gauchos® High Strength (high tensile)	Bekaert 18g Light Duty (high tensile)	Bekaert Classic (low carbon)
Applications	Cattle	○ ○ ○	○ ○	○ ○	○ ○
	Bison	○ ○	—	—	—
	Exclusion	○	—	—	—
Coatings	40 YEARS	YES	YES	—	—
	30 YEARS	YES	YES	—	—
	20 YEARS	YES	YES	—	—

Barbed wire not recommended for: Horse, Llama, Alpaca, Sheep, Goat, Ostrich, Emu, Deer/Elk, Swine

# Barbed Wire Products

Cattleman® Pro Professional Strength Barbed Wire							
Part #	Fence Design	Barb Spacing	Barb Type	Line Wire Diameter	Reel Length	Reel Weight	Coating
135137	2 point	5"	flat	14g	1320'	56 lbs	Class 3
134936	4 point	5"	flat	14g	1320'	65 lbs	Class 3
145733	2 point	5"	flat	14g	1320'	56 lbs	Bezinal® coating
145734	4 point	5"	flat	14g	1320'	65 lbs	Bezinal® coating
135463	2 point	5"	flat	14g	1320'	56 lbs	Bezinal® + Green
135464	4 point	5"	flat	14g	1320'	65 lbs	Bezinal® + Green
235773	barbless	-	-	14g	1320'	45 lbs	Bezinal® coating

Bekaert 18G Light Duty Barbed Wire							
Part #	Fence Design	Barb Spacing	Barb Type	Line Wire Diameter	Reel Length	Reel Weight	Coating
206165	4 point	5"	round	18g	1320'	25 lbs	Class 3

● 20 Year Guarantee ● 30 Year Guarantee ● 40 Year Guarantee

Gauchó® High Strength Barbed Wire							
Part #	Fence Design	Barb Spacing	Barb Type	Line Wire Diameter	Reel Length	Reel Weight	Coating
118290	2 point	5"	flat	15.5g	1320'	41 lbs	Class 3
118293	4 point	5"	round	15.5g	1320'	42 lbs	Class 3
118352	4 point	3"	round	15.5g	1320'	51 lbs	Class 3
261130	2 point	5"	flat	15.5g	1320'	41 lbs	Bezinal® coating
261131	4 point	5"	round	15.5g	1320'	42 lbs	Bezinal® coating
127139	4 point	5"	round	15.5g	1320'	42 lbs	Bezinal® + Green

Bekaert Classic Barbed Wire							
Part #	Fence Design	Barb Spacing	Barb Type	Line Wire Diameter	Reel Length	Reel Weight	Coating
118403	4 point	5"	round	12.5g	1320'	88 lbs	Class 3
120312	2 point	4"	round	12.5g	1320'	82 lbs	Class 1
168986	2 point	5"	round	12.5g	1320'	79 lbs	Class 1
118400	4 point	5"	round	12.5g	1320'	88 lbs	Class 1
118385	barbless	N/A	N/A	12.5g	1320'	64 lbs	Class 1
169494	2 point	5"	round	12.75g	1320'	73 lbs	Commercial
169496	4 point	6"	round	12.75g	1320'	81 lbs	Commercial
601690	2 point	-	flat	-	1320'	62 lbs	Commercial
601701	4 point	-	round	-	1320'	71 lbs	Commercial

# Field Fence

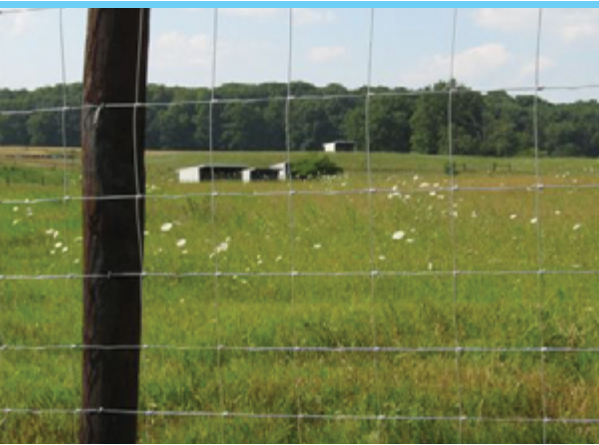

## Benefits

- increased effectiveness versus barbed wire or smooth wire
- withstands impact from large animals
- smaller openings at the bottom designed to prevent small animal entry

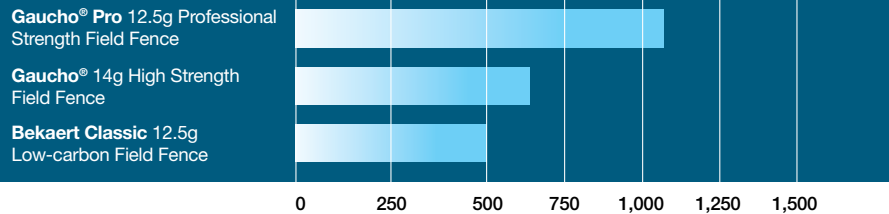

### Woven Wire Breaking Strength (in Pounds)



### Good for:



- ○ ○ Excellent for the job
- ○ Good for the job
- OK for the job
- Not recommended

Field Fence				
Applications And Coatings Chart	Gaucho® Pro Professional Strength (high tensile)	Gaucho® High Strength (high tensile)	Bekaert Classic (low carbon)	
Applications	Cattle	○ ○ ○	○ ○	○ ○
	Bison	○ ○	—	—
	Horse Llama	○	—	—
	Sheep Goat	○ ○ ○	○ ○ ○	○ ○
	Ostrich Emu	○ ○	—	—
	Deer Elk	○	—	—
	Swine	○ ○	○	○
	Exclusion	○ ○	○ ○	○
Coatings	 YES	—	—	
	 YES	YES	—	

30 year guarantee on coating not available

# Field Fence Products

## Gaicho® Pro Professional Strength Field Fence

Part #	Fence Design	Height	Vertical Spacing	Roll Length	Top & Bottom Wire Diameter	Filler Wire Diameter	Roll Weight	Coating
118188	939-6	39"	6"	330'	10.5g	12.5g	106 lbs	Class 3
118158	936-12	39"	12"	330'	10.5g	12.5g	126 lbs	Class 3
118202	1047-6	47"	6"	330'	10.5g	12.5g	188 lbs	Class 3
118176	1047-12	47"	12"	330'	10.5g	12.5g	142 lbs	Class 3
118242	1478-6	78"	6"	330'	12.5g	12.5g	266 lbs	Class 3
127143	1047-6	47"	6"	330'	10.5g	12.5g	188 lbs	Bezinal® + Green



## Gaicho® High Strength Field Fence

Part #	Fence Design	Height	Vertical Spacing	Roll Length	Top & Bottom Wire Diameter	Filler Wire Diameter	Roll Weight	Coating
118391	726-6	26"	6"	330'	12.5g	14g	79 lbs	Class 3
118406	832-6	32"	6"	330'	12.5g	14g	93 lbs	Class 3
118142	939-6	39"	6"	330'	12.5g	14g	106 lbs	Class 3
118155	1047-6	47"	6"	330'	12.5g	14g	120 lbs	Class 3



● 20 Year Guarantee ● 30 Year Guarantee ● 40 Year Guarantee

Comes installed with Gripple® for customer convenience. See page 37 for details.

## Bekaert Classic Field Fence

Part #	Fence Design	Height	Vertical Spacing	Roll Length	Top & Bottom Wire Diameter	Filler Wire Diameter	Roll Weight	Coating
118266	1047-12	47"	12"	330'	9g	9g	311 lbs	Class 3
118181	832-6	32"	6"	330'	10g	12.5g	147 lbs	Class 1
118190	939-6	39"	6"	330'	10g	12.5g	170 lbs	Class 1
118164	939-12	39"	12"	330'	10g	12.5g	130 lbs	Class 1
118207	1047-6	47"	6"	330'	10g	12.5g	194 lbs	Class 1
118182	1047-12	47"	12"	330'	10g	12.5g	147 lbs	Class 1
118233	939-6	39"	6"	330'	9g	11g	246 lbs	Class 1
118251	1047-6	47"	6"	330'	9g	11g	280 lbs	Class 1
118216	1047-12	47"	12"	330'	9g	11g	209 lbs	Class 1
118300	1047-6	47"	6"	330'	9g	9g	417 lbs	Class 1
118265	1047-12	47"	12"	330'	9g	9g	311 lbs	Class 1

## Field Fence

Available in 6" and 12" stays

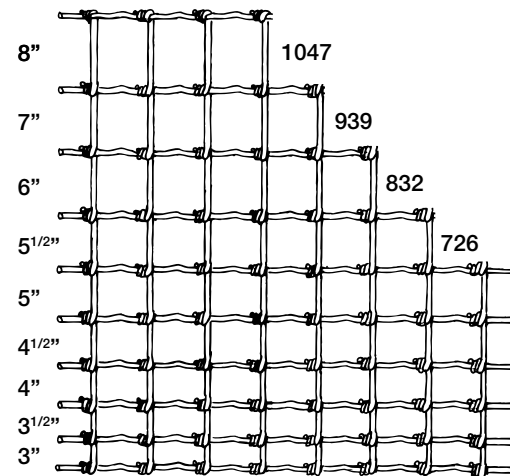

# Non-Climb Fence



## Benefits

- animal-friendly S-knot protects animals’ skin and coat
- 2” x 4” openings reduce risk to equines
- 4” x 4” openings reduce risk to sheep/goats
- 4” x 4” preferred usage for sheep & goats
- smaller openings at the bottom designed to prevent small animal entry
- great option as a residential fence

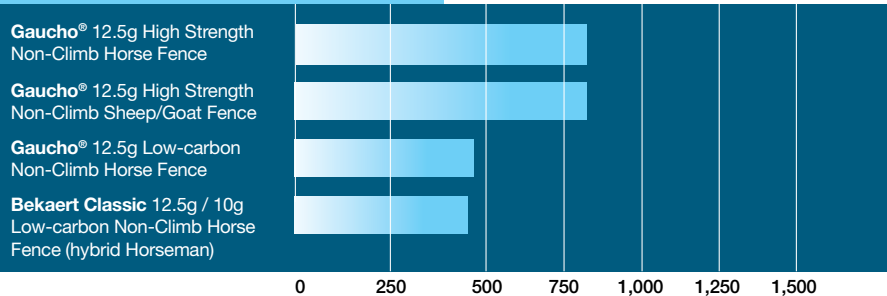

## Woven Wire Breaking Strength (in pounds)



Good for:



- ● ● Excellent for the job
- ● Good for the job
- OK for the job
- Not recommended

Non-Climb Fence				
Applications And Coatings Chart	Gaicho® High Strength, Non-Climb Horse Fence	Gaicho® High Strength Sheep & Goat Fence	Gaicho® Non-Climb Horse Fence	
Applications	Cattle	○	—	
	Horse Llama	● ● ●	○	
	Sheep Goat	● ●	● ● ●	
	Ostrich Emu	● ●	—	
	Exclusion	—	—	○
Coatings		—	—	YES
		YES	YES	—
		—	—	YES

Gaicho® Non-Climb fencing not recommended for: Bison, Deer/Elk, Swine

# Non-Climb Fence Products

Gaucho® High Strength Non-Climb Horse Fence								
Part #	Fence Design	Height	Vertical Spacing	Roll Length	Line Wire Diameter	Stay Wire Diameter	Roll Weight	Coating
164395	1348-2	48"	2"	100'	12.5g	14g	101 lbs	Bezinal® coating
164396	1348-2	48"	2"	200'	12.5g	14g	198 lbs	Bezinal® coating
164397	1660-2	60"	2"	100'	12.5g	14g	125 lbs	Bezinal® coating
164399	1660-2	60"	2"	200'	12.5g	14g	246 lbs	Bezinal® coating
165031	1972-2	72"	2"	100'	12.5g	14g	138 lbs	Bezinal® coating

Gaucho® Non-Climb Horse Fence								
Part #	Fence Design	Height	Vertical Spacing	Roll Length	Line Wire Diameter	Stay Wire Diameter	Roll Weight	Coating
118157	1348-2	48"	2"	100'	10g	12.5g	122 lbs	Class 3
118232	1348-2	48"	2"	200'	10g	12.5g	244 lbs	Class 3
118183	1660-2	60"	2"	100'	10g	12.5g	151 lbs	Class 3
134801	1348-2	48"	2"	100'	10g	12.5g	122 lbs	Bezinal® + Black
134804	1348-2	48"	2"	200'	10g	12.5g	244 lbs	Bezinal® + Black
134808	1660-2	60"	2"	100'	12.5g	12.5g	151 lbs	Bezinal® + Black

Bekaert Classic Non-Climb Horse Fence								
Part #	Fence Design	Height	Vertical Spacing	Roll Length	Line Wire Diameter	Stay Wire Diameter	Roll Weight	Coating
145778	1348-2	48"	2"	100'	12.5g	12.5g	122 lbs	Class 1
145780	1348-2	48"	2"	200'	12.5g	12.5g	248 lbs	Class 1
145781	1660-2	60"	2"	100'	12.5g	12.5g	151 lbs	Class 1
145754	1972-2	72"	2"	100'	12.5g	12.5g	179 lbs	Class 1

Gaucho® High Strength Sheep And Goat Fence								
Part #	Fence Design	Height	Vertical Spacing	Roll Length	Line Wire Diameter	Stay Wire Diameter	Roll Weight	Coating
213412	1348-4	48"	4"	330'	12.5g	14g	218 lbs	Bezinal® coating
230834	1348-4	48"	4"	100'	12.5g	14g	67 lbs	Bezinal® coating

● 20 Year Guarantee ● 30 Year Guarantee ● 40 Year Guarantee

# Fixed Knot Fence

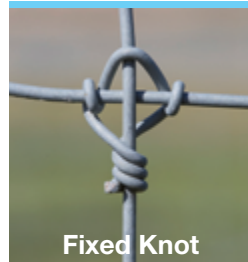

## Benefits

- best option for resistance to animal damage
- solid fence construction allows for increased post spacing
- maximum strength from the knot locks the stay wire in place
- smaller openings at the bottom designed to prevent small animal entry
- increased post spacing thanks to the solid vertical wire design combined with a high strength-to-weight ratio

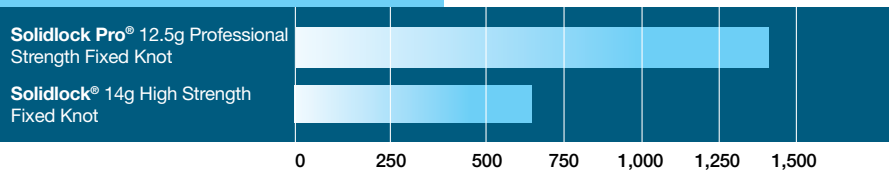

## Woven Wire Breaking Strength (in pounds)



## Good for:



- ○ ○ Excellent for the job
- ○ Good for the job
- OK for the job
- Not recommended

Fixed Knot Fence			
Applications and Coatings Chart	Solidlock® Pro Professional Strength (high tensile)	Solidlock® High Strength (high tensile)	
Applications	Cattle	○ ○ ○	○ ○
	Bison	○ ○ ○	—
	Horse Llama	○ ○ ○	○ ○
	Sheep Goat	○ ○ ○	○ ○ ○
	Ostrich Emu	○ ○ ○	—
	Deer Elk	○ ○ ○	—
	Swine	○ ○ ○	—
	Exclusion	○ ○ ○	○ ○ ○
Coatings	 40 YEARS	YES	—
	 30 YEARS	YES	YES
	 20 YEARS	YES	—

# Fixed Knot Fence Products

Solidlock® Pro Professional Strength Fixed Knot Game Fence							
Part #	Fence Design	Height	Vertical Spacing	Roll Length	Wire Gauge	Roll Weight	Coating
118248	1561-6	61"	6"	330'	12.5g	279 lbs	Class 3
118269	1775-6	75"	6"	330'	12.5g	327 lbs	Class 3
118271	2096-3	96"	3"	165'	12.5g	340 lbs	Class 3
118288	2096-6	96"	6"	330'	12.5g	397 lbs	Class 3
118376	2096-6	96"	6"	500'	12.5g	601 lbs	Class 3
118241	2096-12	96"	12"	330'	12.5g	282 lbs	Class 3
118371	2096-12	96"	12"	660'	12.5g	564 lbs	Class 3
118318	23120-6	120"	6"	330'	12.5g	492 lbs	Class 3
180546	2096-6	96"	6"	330'	12.5g	397 lbs	Bezinal® coating
216657	2096-6	96"	6"	500'	12.5g	600 lbs	Bezinal® coating
136261	2096-6	96"	6"	330'	12.5g	396 lbs	Bezinal® + Black



## Solidlock® Pro Game

Available in 6" and 12" stays; select sizes available with 3" stay spacing

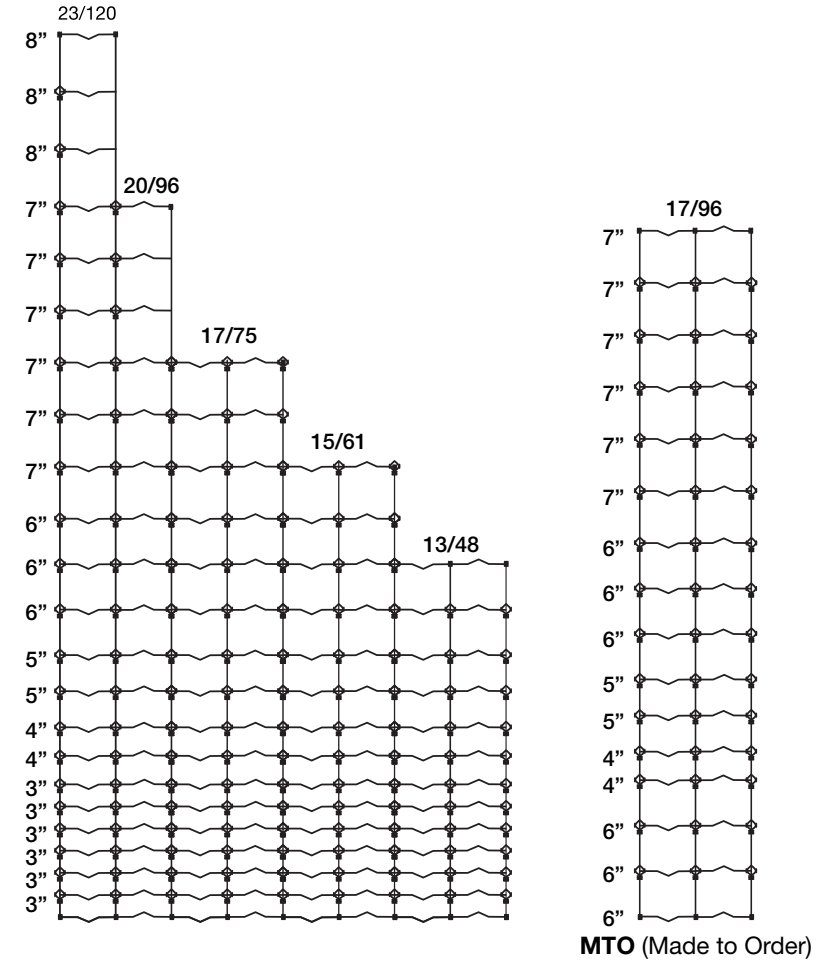

● 20 Year Guarantee ● 30 Year Guarantee ● 40 Year Guarantee

 Comes installed with Gripple® for customer convenience. See page 37 for details.

## Solidlock® Pro Professional Strength Fixed Knot Cattle Fence

Part #	Fence Design	Height	Vertical Spacing	Roll Length	Wire Gauge	Roll Weight	Coating
118185	842-6	42"	6"	330'	12.5g	157 lbs	Class 3
118221	842-12	42"	12"	660'	12.5g	220 lbs	Class 3
118199	949-6	49"	6"	330'	12.5g	182 lbs	Class 3
286945	949-6	49"	6"	500'	12.5g	274 lbs	Class 3
118162	949-12	49"	12"	330'	12.5g	129 lbs	Class 3
118239	949-12	49"	12"	660'	12.5g	257 lbs	Class 3
118218	1060-6	60"	6"	330'	12.5g	210 lbs	Class 3
118257	1060-12	60"	12"	660'	12.5g	294 lbs	Class 3
118226	1348-6	48"	6"	330'	12.5g	237 lbs	Class 3
180682	842-6	42"	6"	330'	12.5g	158 lbs	Bezinal® coating
180710	842-12	42"	12"	660'	12.5g	225 lbs	Bezinal® coating
180541	949-6	49"	6"	330'	12.5g	182 lbs	Bezinal® coating
180545	949-12	49"	12"	660'	12.5g	257 lbs	Bezinal® coating



## Solidlock® Pro Cattle

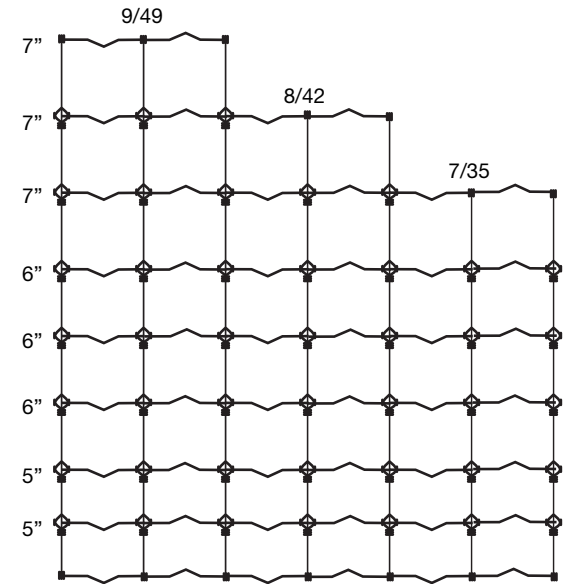
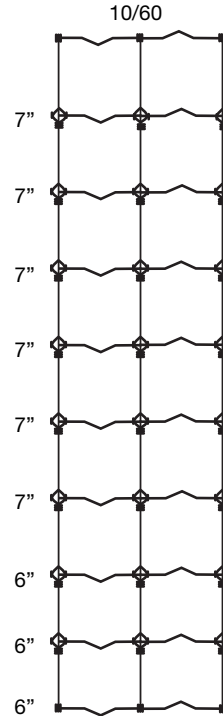

● 20 Year Guarantee ● 30 Year Guarantee ● 40 Year Guarantee

Comes installed with Gripple® for customer convenience. See page 37 for details.

Solidlock® Pro Professional Strength Fixed Knot Horse Fence							
Part #	Fence Design	Height	Vertical Spacing	Roll Length	Wire Gauge	Roll Weight	Coating
118225	1348-3	48"	3"	200'	12.5g	234 lbs	Class 3
118249	1561-3	61"	3"	200'	12.5g	280 lbs	Class 3



### Solidlock® Pro Horse

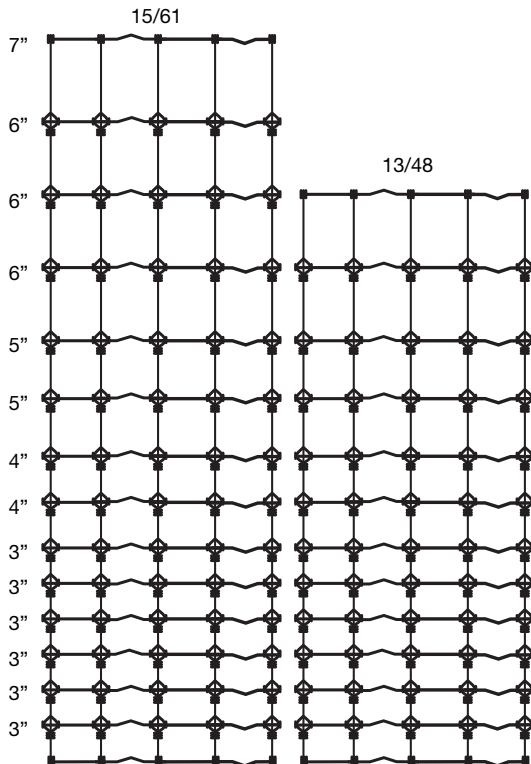

Comes installed with Gripple® for customer convenience. See page 37 for details.

Solidlock® High Strength Fixed Knot							
Part #	Fence Design	Height	Vertical Spacing	Roll Length	Wire Gauge	Roll Weight	Coating
170645	1478-6	78"	6"	165'	14g	105 lbs	Bezinal® coating
157717	1478-6	78"	6"	330'	14g	210 lbs	Bezinal® coating
157718	1690-6	90"	6"	330'	14g	241 lbs	Bezinal® coating



### Solidlock®

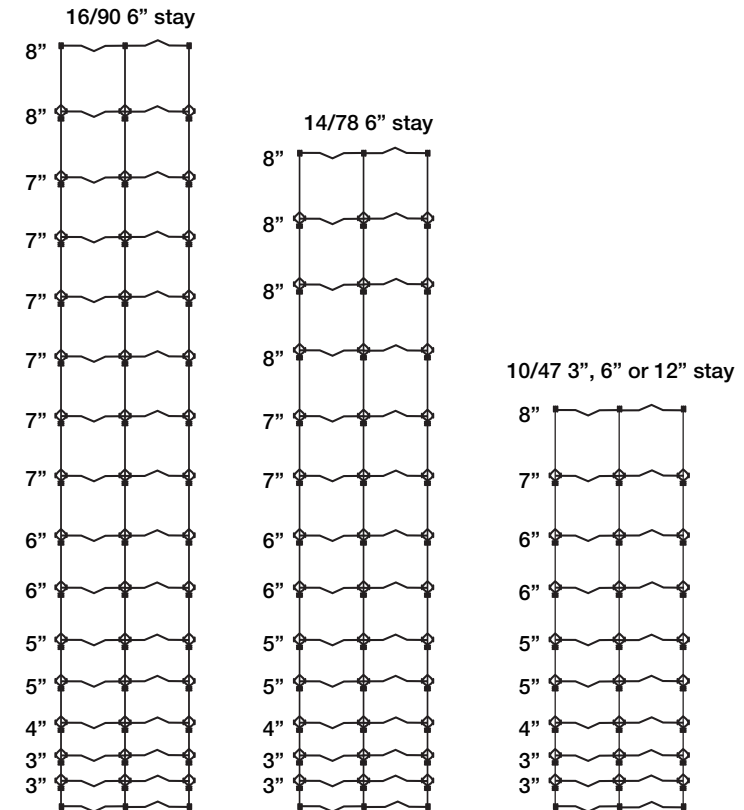

MTO only

# Smooth Wire Fence/ Electric Fence Wire

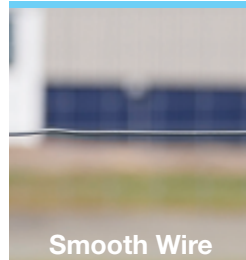

## Benefits

- smooth wire fence - high tensile
- electric fence wire - low-carbon
- best option for permanent electric fencing
- versatile wire for many applications
- single-strand wire perfect for bracing
- very economical and easy to install

- ○ ○ Excellent for the job
- ○ Good for the job
- OK for the job
- Not recommended

Smooth Wire Fence/Electric Fence Wire			
Applications and coatings chart		200 K PSI	170 K PSI
Applications	Cattle	○ ○ ○	○ ○ ○
	Bison	○ ○ ○	○ ○
	Horse Llama	○	○
	Sheep Goat	○	○
	Swine	○ ○	○ ○
	Exclusion	○	○

Smooth Wire Fence/Electric Fence Wire not recommended for:  
Ostrich, Emu, Deer/Elk

20, 30 and 40 year guarantee not available.

Good for:



# Smooth Wire Fence/Electric Fence Wire Products

## Bekaert High Tensile Smooth Wire\*

Part #	Tensile Strength	Length	Weight	Coating
118358	170 K PSI	2,000'	53 lbs	Class 3
118128	170 K PSI	4,000'	100 lbs	Class 3
118361	200 K PSI	2,000'	53 lbs	Class 3
118141	200 K PSI	4,000'	100 lbs	Class 3
154996	170 K PSI	4,000'	100 lbs	Bezinal® coating
154997	200 K PSI	4,000'	100 lbs	Bezinal® coating

## Bekaert High Tensile Reddie Reel™

Part #	Wire Diameter	Length	Coating	Package
120656	12.5g	1,320'	Class 3	Reddie Reel™
181382	12.5g	4,000'	Bezinal® coating	Reddie Reel™

Electric Fence Wire, a low-carbon galvanized wire product, features a single-strand design that allows it to be used for pasture fencing, tying, or bundling, and is offered in 1/4 mile and 1/2 mile reels.

It is designed for permanent cost-efficient fencing needs and general farm/ranch jobs.

## Bekaert Electric Fence Wire

Part #	Wire Diameter	Length	Coating	Package
118220	14g	1,320' (1/4 mile)	galvanized	spool
118306	14g	2,640' (1/2 mile)	galvanized	spool
119752	17g	1,320' (1/4 mile)	galvanized	spool
118244	17g	2,640' (1/2 mile)	galvanized	spool

# The Right Accessories

The right parts can simplify installation and help your fence last longer. Bekaert accessories are made with the same quality construction you'll find in all our fencing solutions.

## Fence Staples



Made from premium 8g Bezinal® coated wire, these **Barbed Fence Staples** feature single or double barbs to maintain fastening and provide easy driving. Shorter staple lengths are suitable for hardwood posts, while longer staple lengths are suitable for softwood posts.

## Fence Stays



Designed to fit our **Gaucha® 15.5g Barbed Wire** and our **Cattleman® Pro 14g Barbed Wire** products, these fencing stays give added strength and rigidity to fences, allowing for increased post spacing.

## Welded Utility Fabric



Welded Utility Fabric can be used as fencing for smaller animals, garden protection, property delineation, livestock shade panels, partitions, corn cribs, and temporary pens.

## Bekaert Fencing System



The Bekaert Fencing System pairs the highest quality fence on the market with Gripple's innovative range of pre-installed components designed to simplify the entire process of installing, maintaining and repairing all types of wire fencing.

The installation of fencing accessories may alter the tensile or breaking strength of fencing. Bekaert corporation makes no warranty whatsoever with respect to the effect of fencing accessories on the tensile or breaking strength of fencing wire.

# Accessories

## Bekaert Barbed Staples

Part #	Description	Wire Diameter	Coating	Package
187235	1.25" barbed	8g	Bezinal® coating	8 lb bucket
187237	1.5" double barbed	8g	Bezinal® coating	8 lb bucket
187244	1.75" double barbed	8g	Bezinal® coating	8 lb bucket
187246	2" double barbed	8g	Bezinal® coating	8 lb bucket
187255	1.25" barbed	8g	Bezinal® coating	50 lb bucket
147613	1.5" double barbed	8g	Bezinal® coating	50 lb bucket
187260	1.75" double barbed	8g	Bezinal® coating	50 lb bucket
162837	2" double barbed	8g	Bezinal® coating	50 lb bucket

## Bekaert Knurled Staples

Part #	Description	Wire Diameter	Coating	Package
118322	1" knurled staples	9g	Class 3	50 lb carton
118323	1.25" knurled staples	9g	Class 3	50 lb carton
118324	1.5" knurled staples	9g	Class 3	50 lb carton
118325	1.75" knurled staples	9g	Class 3	50 lb carton

## Bekaert Fence Stays

Part #	Description	Wire Diameter	Coating	Package
118303	42" open top stays	9.5g	Class 3	Bundle of 100
118314	48" open top stays	9.5g	Class 3	Bundle of 100

# Accessories

Bekaert Welded Utility Wire Fabric				
Part #	Description	Type	Coating	Weight
118224	2x4 14g 36" 50'	utility fabric	galvanized	24 lbs
118311	2x4 14g 36" 100'	utility fabric	galvanized	47 lbs
118263	2x4 14g 48" 50'	utility fabric	galvanized	31 lbs
118378	2x4 14g 48" 100'	utility fabric	galvanized	62 lbs
118285	2x4 14g 60" 50'	utility fabric	galvanized	39 lbs
118389	2x4 14g 60" 100'	utility fabric	galvanized	77 lbs
118309	2x4 14g 72" 50'	utility fabric	galvanized	46 lbs
118408	2x4 14g 72" 100'	utility fabric	galvanized	93 lbs

Bekaert Merchant Quality Low-carbon Wire Coils				
Part #	Wire Diameter	Length	Coating	Package
223896	9g	170'	Class 3	10 lb coil
223897	9g	1710'	Class 3	100 lb coil
118105	11g	270'	Class 1	10 lb coil
118108	14g	585'	Class 1	10 lb coil

# Fence Calculation Guide

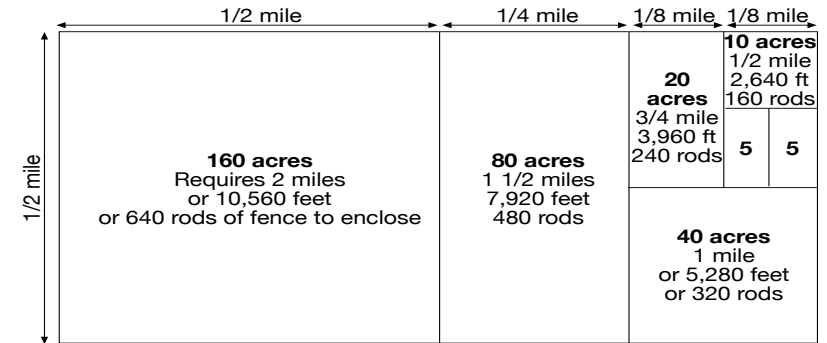

## General Post Spacing Requirements

Post spacing will vary with land conditions and stock pressure. For specific application/installation questions, ask #TheFencePro on our website [fencing.bekaert.com](http://fencing.bekaert.com)

**High tensile field fence:** up to 16.5'

Products: Gaucho® 20 and Gaucho® Pro 20 and 40

**High tensile barbed wire:** up to 30' w/stays

Products: Gaucho® 20, 30, 40, and Cattleman® Pro 20, 30, 40

**High tensile fixed knot fence:** up to 30'

Products: Solidlock® 30, and Solidlock® Pro 20, 30, 40

**High tensile non-climb horse fence:** 8'-12'

Products: Gaucho® 30 horse fence

**High tensile non-climb sheep and goat fence:** 8'-12'

Products: Gaucho® 30 sheep and goat fence

**Bekaert high tensile coils:** up to 30' w/battens

Products: Bekaert 170 K PSI, Bekaert 200 K PSI

**Low-carbon field fence:** 8'

Products: Bekaert Classic field fence

**Low-carbon barbed wire:** up to 12'-15'

Products: Bekaert Classic barbed wire

**Low-carbon non-climb horse fence:** 8'

Products: Gaucho® 20 and 40 horse fence

# Bekaert Fencing System

## Gripple Joiners - Retail Bags

Product	Description	Part #	Bag Qty	Bag Weight (lbs)	Box Qty	Box Weight (lbs)
GP Small	For 17 - 14 ga plain wire, trellis wire, field fence, or electric fence. Working load 660 lbs.	288544	10	0.9	100	4.75
GP Medium	For 13.5 - 10 ga plain wire, trellis wire, field fence, or electric fence. Working load 880 lbs.	288545	10	1.2	100	6.3
GP Large	For 10 - 7.5 ga plain wire, trellis wire, field fence, or electric fence. Working load 1,320 lbs.	288436	10	1.1	100	10.3
Barbed Wire Gripple	For 12.5 ga mild steel barbed wire. Working load 880 lbs.	288462	10	0.6	100	5.8
T-Clip	For 14 - 10 ga plain wire, field fence, or electric fence, and 15 1/2 ga high tensile barbed wire.	288463	10	0.8	100	6.3
T-Clip 2 (Barbed Wire)	For 10 - 7.5 ga plain wire, field fence, or electric fence, and 12.5 ga mild steel barbed wire.	288546	10	100	120	8.3

## Tensioning Tools

Product	Description	Part #	Bag Qty	Bag Weight (lbs)	Box Qty	Box Weight (lbs)
Torq Tensioning Tool	Made of strong glass nylon, this light and compact tool allows tensioning of wire/cable through a Gripple joiner on your fencing	288592	1	2.6	4	11.2
Contractor Tensioning Tool	Metal construction, longer handles, higher gear ration, and wider cam for tensioning wire/cable through all sizes of Gripple	288593	1	5.5	4	22.3

## Bracing Kits

Product	Description	Part #	Bag Qty	Bag Weight (lbs)	Box Qty	Box Weight (lbs)
GPAK4, 16.5ft (1/bag)	16.5' of 5/32" thick, 1x19 strand cable with pre-ferruled loop and Large Gripple. Designed for high load vineyard and H-Bracing fencing applications.	288596	1	1.6	10	11.2
GPAK4, 16.5ft -Bulk	16.5' of 5/32" thick, 1x19 strand cable with pre-ferruled loop and Large Gripple. Designed for high load vineyard and H-Bracing fencing applications.	288591	NA		40	35

## Gripple Joiners - Bulk Jars

Product	Description	Part #	Bag Qty	Bag Weight (lbs)	Box Qty	Box Weight (lbs)
GP Medium, 200 Count	For 13.5 - 10 ga plain wire, trellis wire, field fence, or electric fence. Working Load 880 lbs.	288555	NA	1.2	200	12
T-Clip, 150 Count	For 14 - 10 ga plain wire, field fence, or electric fence, and 15 1/2 ga high tensile barbed wire. Working Load 880 lbs.	288557	NA	0.8	150	12

## Accessories

Product	Description	Part #	Bag Qty	Bag Weight (lbs)	Box Qty	Box Weight (lbs)
Blue Flag Release Key	This setting key allows a Gripple joiner to be adjusted before tension is applied	288554	2	--	20	--
Gripple Twisters (Blue or Grey)	The Gripple Twister secures tail/tag wires to create an aesthetic, hazard-free finish.	288559	100	0.3	1000	4
Cam Set for Torq Tool	Replacement cam set for the Gripple Torq tool	288563	--	--	1	0.3
Cam Set for Contractor Tool	Replacement cam set for the Gripple Contractor tool	288567	--	--	1	0.3
Small Cable Cutter	Designed for cutting cable in the 1/8" - 5/32" range.	288595	1	0.7	10	7.6
Large Cable Cutter	Designed for cutting cable in the 3/16" - 1/4" range	288582	1	2.9	1	2.9

# The Right Partner

Since 1880, Bekaert has developed agricultural products that meet the needs and exceed the expectations of the farmers and landowners we serve. Today, Bekaert is one of the largest independent wire drawing companies in the world. With a state-of-the-art steel wire and agricultural fencing plant located in Van Buren, Arkansas, we're proud to manufacture American-made products.

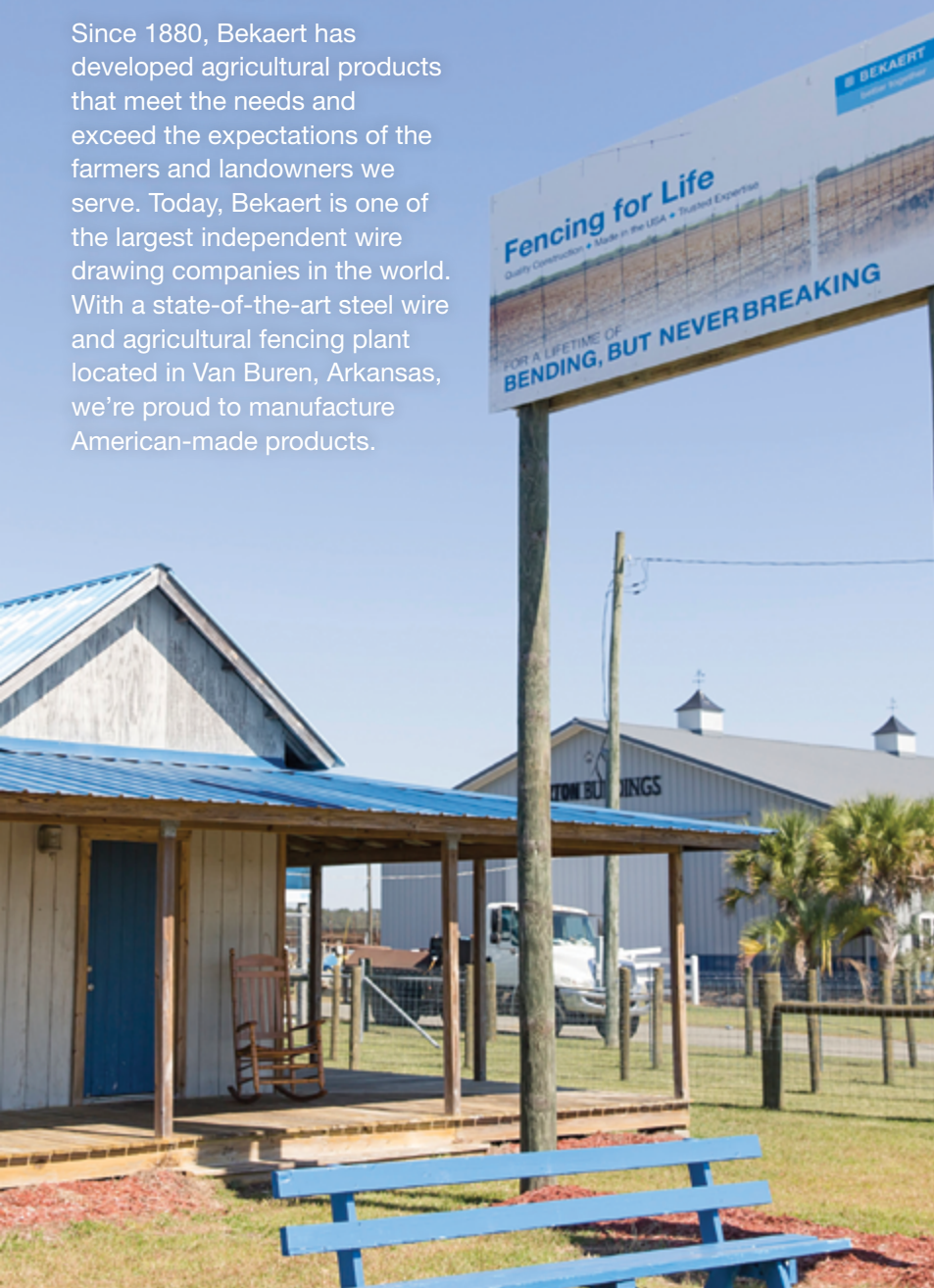

## Glossary

- **Barb:** flat vs round.  
A round barb uses a standard round wire in the barb. A flat barb uses a wire that has been flattened in the barb.
- **Bezinal® coating:** developed and produced exclusively by Bekaert, it is our advanced hybrid zinc-aluminum coating that helps your fence last longer. Bezinal® outperforms galvanized coatings by at least 3 to 1 (for the same coating weight).
- **Bezinal®+ UV Resistant Paint:** developed and produced exclusively by Bekaert, it is our superior hybrid coating that extends the lifetime your fence. Outperforming galvanized coatings by at least 4 to 1 (for the same coating weight), Bezinal®+ UV coating has an added top coat of UV resistant paint. It gives your fence an attractive green or black finish and guards against rust.
- **Class 1 coating:** basic zinc alloy protection against rust; ASTM standards require .28 oz/ft<sup>2</sup> for 12.5 gauge wire. Class 1 offers protection against rust for 5-10 years.
- **Class 3 coating:** improved zinc alloy protection against rust; ASTM standards require .80 oz/ft<sup>2</sup> for 12.5 gauge wire.
- **Commercial coating:** basic zinc alloy protection against rust; without ASTM standards. Commercial coating offers protection against rust for 1-3 years.
- **Fence design:** numerical description for the construction of the fence, e.g. 1047-6.

- **Filler wire:** the main line wire diameter in field fence, this size does not include the top and bottom wire.
- **Fixed knot:** utilizes solid vertical stay wires, which increases the vertical strength of the fence and allows for increased post spacing. The knot is a separate piece of wire tightly wrapped around the line wire and stay wire.
- **Galvanization:** the process of applying a protective zinc coating to steel or iron, to prevent rusting. Galvanizing protects in two ways:
  1. It forms a coating of corrosion-resistant zinc that prevents corrosive substances from reaching the more delicate part of the metal.
  2. The zinc serves as a sacrificial anode so that even if the coating is scratched, the exposed steel will still be protected by the remaining zinc.
- **Hinge joint:** is formed by wrapping the vertical stay wire pieces around the line wire at each intersection. This design can absorb animal impact without damage.
- **Line wire:** the horizontal wires that make up a woven wire fence.
- **Part number:** unique numerical identifier for a particular product design.
- **Reel length:** the measurement of the fence on each reel, or roll, from end to end.
- **Reel/roll weight:** the physical weight of one unit of a given product.
- **Steel wire rod:** rolled alloy or non-alloy steel product, produced from a semi and having a round cross-section. Wire rod is wound into coils and transported in this form.
- **“S” knot:** uses a separate piece of wire to attach the line wire to the solid stay wire. The “S” knot is smooth to the touch and strong enough to resist animal impact. The animal friendly “S”-knot protects animals’ skin and coat.
- **Stay wires:** the vertical wires that make up a woven wire fence.
- **Stay spacing:** the distance between the vertical wires in a woven wire fence.
- **Tensile strength:** measures the force required to pull wire to the point where it breaks.
- **Top wire and bottom wire:** to increase the strength, field fence products often have larger wire gauges for the top and bottom wire that differs from the gauge of the filler wire.

## Would you like to learn more about anything in this catalog?

Please do not hesitate to get in touch  
with us. Give us a call at [1-800-241-4126](tel:1-800-241-4126)  
or go online to ask #TheFencePro or find  
a dealer near you.

[fencing.bekaert.com](http://fencing.bekaert.com)



**Made in the USA**

**Bekaert Corporation**  
1395 S. Marietta Pkwy  
Building 500; Suite 100  
Marietta, GA 30067

**Bekaert Van Buren**  
1881 Bekaert Drive  
Van Buren, AR 72956

 **BEKAERT**

better together