

FASNSEAL W2 - Double-Wall

Vent Length

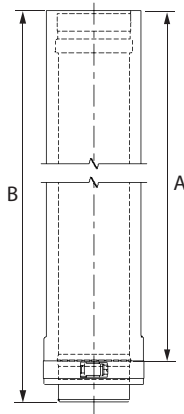

Used for venting special gas burning Categories II, III and IV appliances.

SIZE	ORDER #	STOCK #	A	B	SIZE	ORDER #	STOCK #	A	B
3"	100001	W2-603	4"	6"	10"	100067	W2-2410	22"	24"
3"	100015	W2-1203	10"	12"	10"	100082	W2-3610	34"	36"
3"	100045	W2-1803	16"	18"	12"	100009	W2-612	4"	6"
3"	100060	W2-2403	22"	24"	12"	100023	W2-1212	10"	12"
3"	100075	W2-3603	34"	36"	12"	100053	W2-1812	16"	18"
4"	100002	W2-604	4"	6"	12"	100068	W2-2412	22"	24"
4"	100016	W2-1204	10"	12"	12"	100083	W2-3612	34"	36"
4"	100046	W2-1804	16"	18"	14"	100010	W2-614	4"	6"
4"	100061	W2-2404	22"	24"	14"	100024	W2-1214	10"	12"
4"	100076	W2-3604	34"	36"	14"	100054	W2-1814	16"	18"
5"	100003	W2-605	4"	6"	14"	100069	W2-2414	22"	24"
5"	100017	W2-1205	10"	12"	14"	100084	W2-3614	34"	36"
5"	100047	W2-1805	16"	18"	16"	100011	W2-616	4"	6"
5"	100062	W2-2405	22"	24"	16"	100025	W2-1216	10"	12"
5"	100077	W2-3605	34"	36"	16"	100055	W2-1816	16"	18"
6"	100004	W2-606	4"	6"	16"	100070	W2-2416	22"	24"
6"	100018	W2-1206	10"	12"	16"	100085	W2-3616	34"	36"
6"	100048	W2-1806	16"	18"	18"	103905	W2-618	4"	6"
6"	100063	W2-2406	22"	24"	18"	103909	W2-1218	10"	12"
6"	100078	W2-3606	34"	36"	18"	103913	W2-1818	16"	18"
7"	100005	W2-607	4"	6"	18"	103917	W2-2418	22"	24"
7"	100019	W2-1207	10"	12"	18"	103921	W2-3618	34"	36"
7"	100049	W2-1807	16"	18"	20"	103906	W2-620	4"	6"
7"	100064	W2-2407	22"	24"	20"	103910	W2-1220	10"	12"
7"	100079	W2-3607	34"	36"	20"	103914	W2-1820	16"	18"
8"	100006	W2-608	4"	6"	20"	103918	W2-2420	22"	24"
8"	100020	W2-1208	10"	12"	20"	103922	W2-3620	34"	36"
8"	100050	W2-1808	16"	18"	22"	103907	W2-622	4"	6"
8"	100065	W2-2408	22"	24"	22"	103911	W2-1222	10"	12"
8"	100080	W2-3608	34"	36"	22"	103915	W2-1822	16"	18"
9"	100007	W2-609	4"	6"	22"	103919	W2-2422	22"	24"
9"	100021	W2-1209	10"	12"	22"	103923	W2-3622	34"	36"
9"	100051	W2-1809	16"	18"	24"	103908	W2-624	4"	6"
9"	100066	W2-2409	22"	24"	24"	103912	W2-1224	10"	12"
9"	100081	W2-3609	34"	36"	24"	103916	W2-1824	16"	18"
10"	100008	W2-610	4"	6"	24"	103920	W2-2424	22"	24"
10"	100022	W2-1210	10"	12"	24"	103924	W2-3624	34"	36"
10"	100052	W2-1810	16"	18"					

Adjustable Vent Length

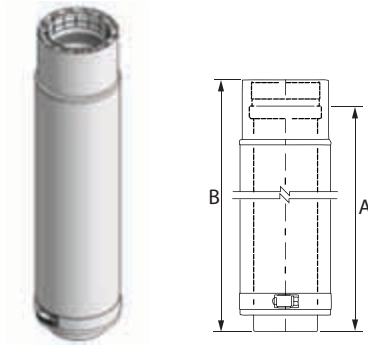

Use to add length to your straight length of FasNSeal pipe. Adds 2"–14" of length. Requires at least 2" overlap for a secure connection.

SIZE	ORDER #	STOCK #	A	B	SIZE	ORDER #	STOCK #	A	B
3"	100250	W2-AVL3	2"-14"	18"	12"	100258	W2-AVL12	2"-14"	18"
4"	100251	W2-AVL4	2"-14"	18"	14"	100259	W2-AVL14	2"-14"	18"
5"	100252	W2-AVL5	2"-14"	18"	16"	100260	W2-AVL16	2"-14"	18"
6"	100253	W2-AVL6	2"-14"	18"	18"	103937	W2-AVL18	2"-14"	18"
7"	100254	W2-AVL7	2"-14"	18"	20"	103938	W2-AVL20	2"-14"	18"
8"	100285	W2-WT8	2"-14"	18"	22"	103939	W2-AVL22	2"-14"	18"
9"	100256	W2-AVL9	2"-14"	18"	24"	103940	W2-AVL24	2"-14"	18"
10"	100257	W2-AVL10	2"-14"	18"					

90° Elbow

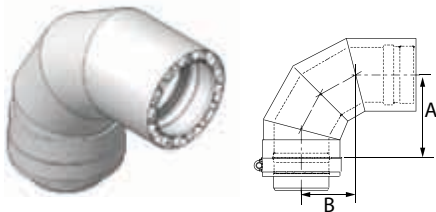

Use to go from horizontal to vertical runs or vertical to horizontal runs. Use to turn vent 90°.

SIZE	ORDER #	STOCK #	A	B	SIZE	ORDER #	STOCK #	A	B
3"	100160	W2-9003	3 9/10"	5 9/10"	12"	100168	W2-9012	8 3/5"	10 3/5"
4"	100161	W2-9004	4 3/5"	6 3/5"	14"	100169	W2-9014	9 3/5"	11 3/5"
5"	100162	W2-9005	4 9/10"	6 9/10"	16"	100170	W2-9016	10 1/10"	12 3/5"
6"	100163	W2-9006	5 3/5"	7 3/5"	18"	103929	W2-9018	11 1/2"	13 4/11"
7"	100164	W2-9007	5 9/10"	7 9/10"	20"	103930	W2-9020	12 3/12"	14 4/11"
8"	100165	W2-9008	6 3/5"	8 3/5"	22"	103931	W2-9022	13 3/12"	15 4/11"
9"	100166	W2-9009	6 9/10"	8 9/10"	24"	103932	W2-9024	14 3/12"	16 4/11"
10"	100167	W2-9010	7 3/5"	9 3/5"					

88° Elbow

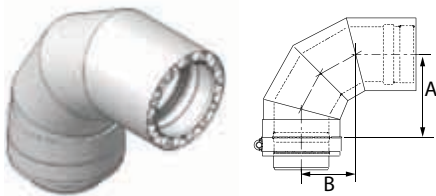

Use to transition from a vertical to a horizontal run. Stabilizes a 2° pitch towards the condensate drain for good condensate management.

SIZE	ORDER #	STOCK #	A	B	SIZE	ORDER #	STOCK #	A	B
3"	103890	W2-8803	3 9/10"	5 9/10"	12"	103898	W2-8812	8 3/5"	10 3/5"
4"	103891	W2-8804	4 3/5"	6 3/5"	14"	103899	W2-8814	9 3/5"	11 3/5"
5"	103892	W2-8805	4 9/10"	6 9/10"	16"	103900	W2-8816	10 1/10"	12 3/5"
6"	103893	W2-8806	5 3/5"	7 3/5"	18"	103901	W2-8818	11 1/2"	13 4/11"
7"	103894	W2-8807	5 9/10"	7 9/10"	20"	103902	W2-8820	12 3/12"	14 4/11"
8"	103895	W2-8808	6 3/5"	8 3/5"	22"	103903	W2-8822	13 3/12"	15 4/11"
9"	103896	W2-8809	6 9/10"	8 9/10"	24"	103904	W3-8824	14 3/12"	16 4/11"
10"	103897	W2-8810	7 3/5"	9 3/5"					

45° Elbow

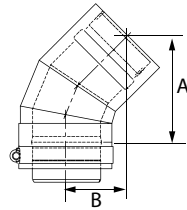

Offsets obstructions as needed. Allows for better condensate management and less back pressure.

SIZE	ORDER #	STOCK #	A	B
3"	100130	W2-4503	5 1/5"	3"
4"	100131	W2-4504	5 3/5"	3 1/10"
5"	100132	W2-4505	6"	3 1/5"
6"	100133	W2-4506	6 3/10"	3 3/5"
7"	100134	W2-4507	6 7/10"	3 1/2"
8"	100135	W2-4508	7"	3 7/10"
9"	100136	W2-4509	7 3/5"	3 4/5"
10"	100137	W2-4510	7 7/10"	4"

SIZE	ORDER #	STOCK #	A	B
12"	100138	W2-4512	8 2/5"	4 3/10"
14"	100139	W2-4514	9 1/10"	4 7/10"
16"	100140	W2-4516	9 4/5"	4 9/10"
18"	103925	W2-4518	11 1/2"	7 7/10"
20"	103926	W2-4520	12	8 1/5"
22"	103927	W2-4522	13	8 7/10"
24"	103928	W2-4524	14"	9 1/5"

30° Elbow

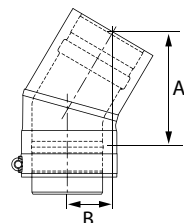

Offsets obstructions as needed.

SIZE	ORDER #	STOCK #	A	B
3"	100650	W2-3003	4 9/10"	1 4/5"
4"	100651	W2-3004	5 1/5"	1 9/10"
5"	100652	W2-3005	5 3/5"	2"
6"	100653	W2-3006	5 7/10"	2"
7"	100654	W2-3007	5 9/10"	2 1/10"
8"	100655	W2-3008	6 1/10"	2 1/5"

SIZE	ORDER #	STOCK #	A	B
9"	100656	W2-3009	6 3/5"	2 1/5"
10"	100657	W2-3010	6 7/10"	2 3/10"
12"	100658	W2-3012	7 1/5"	2 2/5"
14"	100659	W2-3014	7 7/10"	2 3/5"
16"	100660	W2-3016	8 1/5"	2 7/10"

15° Elbow

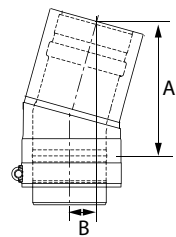

Offsets obstructions as needed.

SIZE	ORDER #	STOCK #	A	B
3"	100239	W2-1503	4 9/10"	1 4/5"
4"	100240	W2-1504	5 1/5"	1 9/10"
5"	100241	W2-1505	5 3/5"	2"
6"	100242	W2-1506	5 7/10"	2"
7"	100243	W2-1507	5 9/10"	2 1/10"
8"	100244	W2-1508	6 1/10"	2 1/5"

SIZE	ORDER #	STOCK #	A	B
9"	100245	W2-1509	6 3/5"	2 1/5"
10"	100246	W2-1510	6 7/10"	2 3/10"
12"	100247	W2-1512	7 1/5"	2 2/5"
14"	100248	W2-1514	7 7/10"	2 3/5"
16"	100249	W2-1516	8 1/5"	2 7/10"

Standard Tee

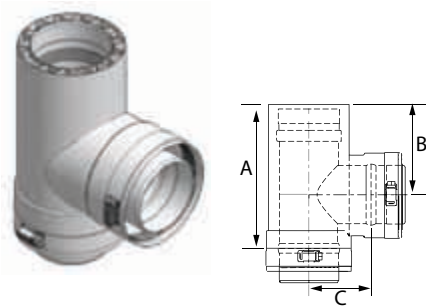

Use for a 90° offset, to combine connections from two or more appliances into a common vent or as a condensate management point when used in conjunction with drain fitting. All Standard Tees are completely welded.

SIZE	ORDER #	STOCK #	A	B	C	SIZE	ORDER #	STOCK #	A	B	C
3"	100175	W2-T3	7 3/10"	4 1/2"	3"	12"	100183	W2-T12	16 3/10"	9"	7"
4"	100176	W2-T4	8 3/10"	4 4/5"	3 1/2"	14"	100184	W2-T14	20 3/10"	11"	8 1/2"
5"	100177	W2-T5	9 3/10"	5 3/10"	4"	16"	100185	W2-T16	22 3/10"	12"	9 1/2"
6"	100178	W2-T6	10 3/10"	5 4/5"	4 1/2"	18"	103933	W2-T18	22 7/8"	12 1/2"	11"
7"	100179	W2-T7	11 3/10"	6 3/10"	5"	20"	103934	W2-T20	24 7/8"	13 1/2"	12"
8"	100180	W2-T8	12 3/10"	6 4/5"	5 1/2"	22"	103935	W2-T22	26 7/8"	14 1/2"	13"
9"	100181	W2-T9	13 3/10"	7 3/10"	6"	24"	103936	W2-T24	28 7/8"	15 1/2"	14"
10"	100182	W2-T10	14 3/10"	7 4/5"	6 1/2"						

Tee Cap

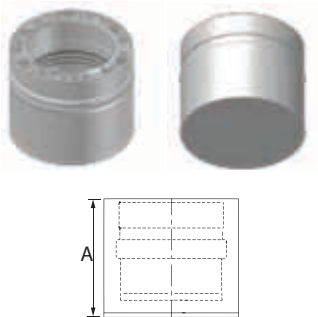

Use to cap Standard Tee, Branch Tee or Boot Tee. Remove Tee Cap to inspect the system; clean out debris or collected condensate.

SIZE	ORDER #	STOCK #	A	SIZE	ORDER #	STOCK #	A
3"	100205	W2-TC3	3 1/2"	12"	100213	W2-TC12	3 1/2"
4"	100206	W2-TC4	3 1/2"	14"	100214	W2-TC14	3 1/2"
5"	100207	W2-TC5	3 1/2"	16"	100215	W2-TC16	3 1/2"
6"	100208	W2-TC6	3 1/2"	18"	103941	W2-TC18	3"
7"	100209	W2-TC7	3 1/2"	20"	103942	W2-TC20	3"
8"	100210	W2-TC8	3 1/2"	22"	103943	W2-TC22	3"
9"	100211	W2-TC9	3 1/2"	24"	103944	W2-TC24	3"
10"	100212	W2-TC10	3 1/2"				

Drain Fitting

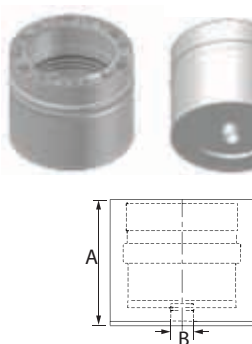

Use instead of Tee Cap to manage condensates at the bottom of a vertical run.

SIZE	ORDER #	STOCK #	A	B	SIZE	ORDER #	STOCK #	A	B
3"	100220	W2-DF3	3 1/2"	5/8"	12"	100228	W2-DF12	3 1/2"	5/8"
4"	100221	W2-DF4	3 1/2"	5/8"	14"	100229	W2-DF14	3 1/2"	5/8"
5"	100222	W2-DF5	3 1/2"	5/8"	16"	100230	W2-DF16	3 1/2"	5/8"
6"	100223	W2-DF6	3 1/2"	5/8"	18"	103945	W2-DF18	3 1/2"	5/8"
7"	100224	W2-DF7	3 1/2"	5/8"	20"	103946	W2-DF20	3 1/2"	5/8"
8"	100225	W2-DF8	3 1/2"	5/8"	22"	103947	W2-DF22	3 1/2"	5/8"
9"	100226	W2-DF9	3 1/2"	5/8"	24"	103948	W2-DF24	3 1/2"	5/8"
10"	100227	W2-DF10	3 1/2"	5/8"					

IPS Drain Fitting

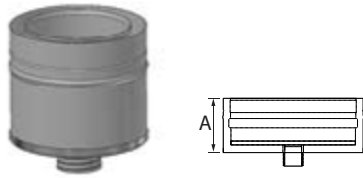

Use to connect iron drain pipe to flow acidic condensates to a neutralization tank before disposal.

SIZE	ORDER #	STOCK #	A	SIZE	ORDER #	STOCK #	A
3"	103815	W2-IPSDF3	3 1/2"	12"	103823	W2-IPSDF12	3 1/2"
4"	103816	W2-IPSDF4	3 1/2"	14"	103824	W2-IPSDF14	3 1/2"
5"	103817	W2-IPSDF5	3 1/2"	16"	103825	W2-IPSDF16	3 1/2"
6"	103818	W2-IPSDF6	3 1/2"	18"	103945	W2-IPSDF18	3 1/2"
7"	103819	W2-IPSDF7	3 1/2"	20"	103946	W2-IPSDF20	3 1/2"
8"	103820	W2-IPSDF8	3 1/2"	22"	103947	W2-IPSDF22	3 1/2"
9"	103821	W2-IPSDF9	3 1/2"	24"	103948	W2-IPSDF24	3 1/2"
10"	103822	W2-IPSDF10	3 1/2"				

Wall Thimble w/AVL

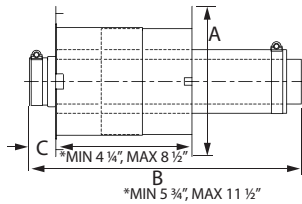
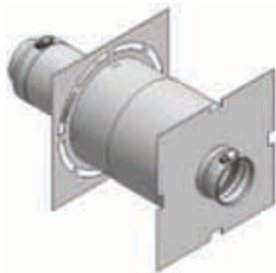

Use for through-the-wall termination. Fits between standard wall studs. 3"-5" diameters accommodates wall thickness of 4 1/4" to 8 1/2". 6"-16" diameters accommodate wall thickness of 5 3/4" to 11 1/2". AVL pipe allows for adjustability in length variance.

SIZE	ORDER #	STOCK #	A	B	C
3"	100280	W2-WT3	9"	18"	1 1/5"
4"	100281	W2-WT4	10"	18"	1 1/5"
5"	100282	W2-WT5	11"	18"	1 1/5"
6"	100283	W2-WT6	12"	18"	1 1/5"
7"	100284	W2-WT7	13"	18"	1 1/5"
8"	100285	W2-WT8	14"	18"	1 1/5"
9"	100286	W2-WT9	15"	18"	1 1/5"
10"	100287	W2-WT10	16"	18"	1 1/5"
12"	100289	W2-WT12	18"	18"	1 1/5"
14"	100290	W2-WT14	20"	18"	1 1/5"
16"	100291	W2-WT16	22"	18"	1 1/5"

Rain Cap

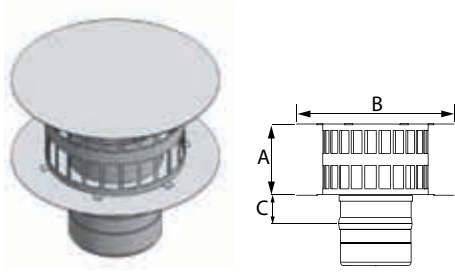

Use where pipe terminates above the roof line.

SIZE	ORDER #	STOCK #	A	B	C
3"	100325	W2-RC3	3 1/2"	6 1/2"	1"
4"	100326	W2-RC4	4 1/2"	8 9/10"	1"
5"	100327	W2-RC5	5 5/8"	11 3/10"	1"
6"	100328	W2-RC6	6 5/8"	13 1/2"	1"
7"	100329	W2-RC7	7 5/8"	15 5/8"	1"
8"	100330	W2-RC8	8 5/8"	18"	1"
9"	100331	W2-RC9	10"	20 3/10"	1"
10"	100332	W2-RC10	11"	22 1/2"	1"
12"	100333	W2-RC12	13"	27"	1"
14"	100334	W2-RC14	15"	31 1/2"	1"
16"	100335	W2-RC16	17"	36"	1"

Termination Cone

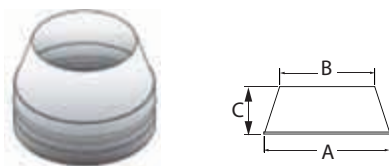

Use for vertical termination. Creates static back pressure to adjust harmonics. Venturi effect increases velocity of flue gases. Reduced opening provides for a smaller cross section to deter rain from entering the system. Can be ordered in any size combination.

SIZE	ORDER #	STOCK #	A	B	C
8"-6"	100618	W2-CN0806	8"	6"	6 3/5"
14"-12"	100622	W2-CN1412	14"	12"	6 3/5"

Stepped Increaser

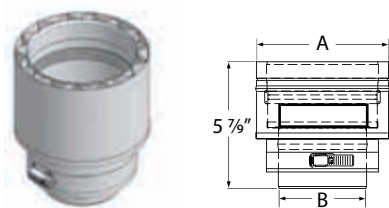

Use to increase vent diameter when space constraints are an issue. Can be ordered to adjoin any size combination.

SIZE	ORDER #	STOCK #	A	B
4"-5"	100381	W2-45I	5"	4"
8"-9"	100401	W2-89I	9"	8"

Tapered Increaser

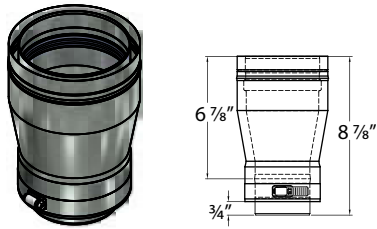

Use to reduce vent diameter. Creates a smooth transition for an undistruptive flow. Can be ordered to adjoin many size combinations.

SIZE	ORDER #	STOCK #
3"	100407	W2-0304TI
3"	100406	W2-0306TI

Eccentric Increaser

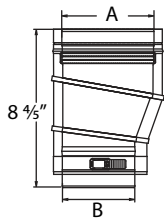

Use to transition to a larger diameter pipe. Adjusts the systems center point to offset from obstructions. Aids in reducing formation of condensates. Can be ordered to adjoin many size combinations.

SIZE	ORDER #	STOCK #	A	B
8" x 10"	100439	W2-0810EI	10"	8"

Stepped Reducer

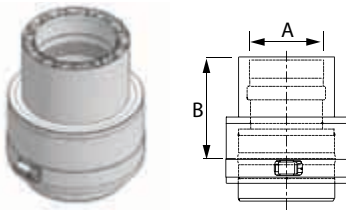

Use to reduce vent diameter when space constraints are an issue. Can be ordered to adjoin any size combination.

SIZE	ORDER #	STOCK #	A	B
7" x 5"	100638	W2-75R	5"	4 3/10"
12" x 10"	100403	W2-1210R	10"	4 3/10"

Tapered Reducer

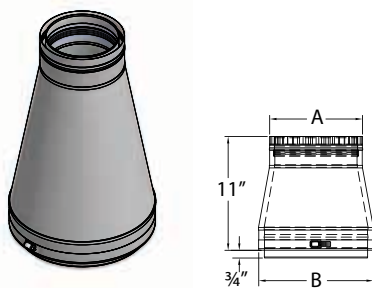

Use to reduce vent diameter. Creates a smooth transition for an undistruptive flow. Can be ordered to adjoin many size combinations.

SIZE	ORDER #	STOCK #	A	B
8"	100395	W2-0807TR	7"	8"
10"	100369	W2-1007TR	7"	10"

Universal Appliance Adapter

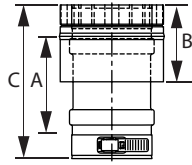

Use to connect double-wall vent pipe to most appliances.

SIZE	ORDER #	STOCK #	A	B	C
3"	100340	W2-AA3	4 4/5"	3"	6"
4"	100341	W2-AA4	4 4/5"	3"	6"
5"	100557	W2-AA5	4 4/5"	3"	6"
6"	100412	W2-AA6	4 4/5"	3"	6"
7"	100413	W2-AA7	4 4/5"	3"	6"
8"	100414	W2-AA8	4 4/5"	3"	6"
9"	100415	W2-AA9	4 4/5"	3"	6"
10"	100416	W2-AA10	4 4/5"	3"	6"
12"	100417	W2-AA12	4 4/5"	3"	6"
14"	100418	W2-AA14	4 4/5"	3"	6"
16"	100419	W2-AA16	4 4/5"	3"	6"

Single-Wall Adapter

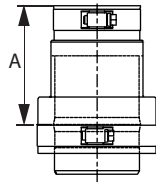

Use to transition from double-wall pipe to single-wall pipe.

SIZE	ORDER #	STOCK #	A
3"	100193	FSA-DWSW3	4"
4"	100194	FSA-DWSW4	4"
5"	100195	FSA-DWSW5	4"
6"	100196	FSA-DWSW6	4"
7"	100197	FSA-DWSW7	4"
8"	100198	FSA-DWSW8	4"
9"	100199	FSA-DWSW9	4"
10"	100200	FSA-DWSW10	4"
12"	100201	FSA-DWSW12	4"
14"	100202	FSA-DWSW14	4"
16"	100203	FSA-DWSW16	4"