



LAVATORY FAUCET

- **Icon Collection**
- **Single-Handle Deck Mount**
- **Integrated Supply Lines**
- **1-Hole Installation**
- **Tall Version**

STANDARD SPECIFICATIONS

- Ceramic disc cartridge
- Less pop-up assembly
- Flexible stainless steel hose inlets
- 1.2gpm max @ 60psi

FINISHES INCLUDE

- Chrome (UF30300)
- Brushed nickel (UF30303)

WARRANTY

- Limited lifetime warranty on workmanship and materials to the original purchaser

COMPLIES WITH

- NSF 61-9
- ASME A112.18.1
- CSA B125.1
- cUPC
- AB1953

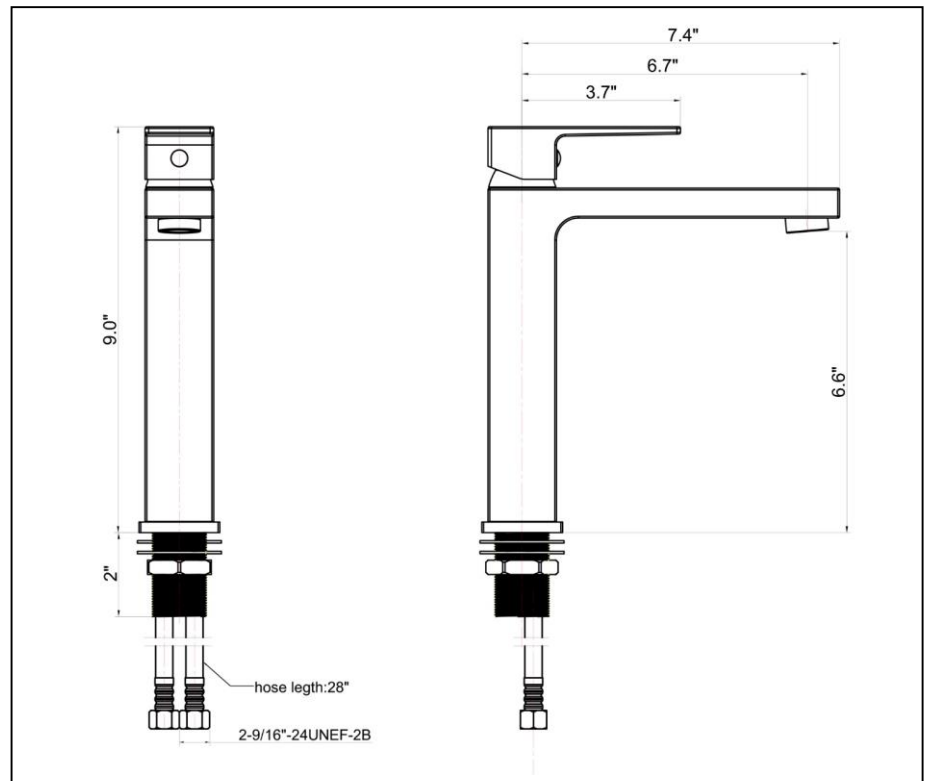

tel. 888-OK-ULTRA (658-5872) • fax. 949-225-6099 • <http://www.ultrafaucets.com>

This specification is provided for reference only. Ultra Faucets reserves the right to modify specifications and materials without notice or obligation.