

Features

- Left-hand trip lever.
- Solid-brass construction for durability.
- KOHLER finishes resist corrosion and tarnish.
- For use with the K-3575 and K-3577 Wellworth Classic toilets.
- Coordinates with other products in the Wellworth Collection.



ADA CSA B651 OBC

Codes/Standards









ASME A112.18.1/CSA B125.1
ADA
ICC/ANSI A117.1
CSA B651
OBC

KOHLER® One-Year Limited Warranty

See website for detailed warranty information.

Available Color/Finishes

Color tiles intended for reference only.

Color	Code	Description
	SN	Vibrant® Polished Nickel
	PB	Vibrant® Polished Brass
	BN	Vibrant® Brushed Nickel
	BV	Vibrant® Brushed Bronze
	2BZ	Oil-Rubbed Bronze
	0	White
	RGD	
	TT	Titanium
	VNT	Vintage Nickel

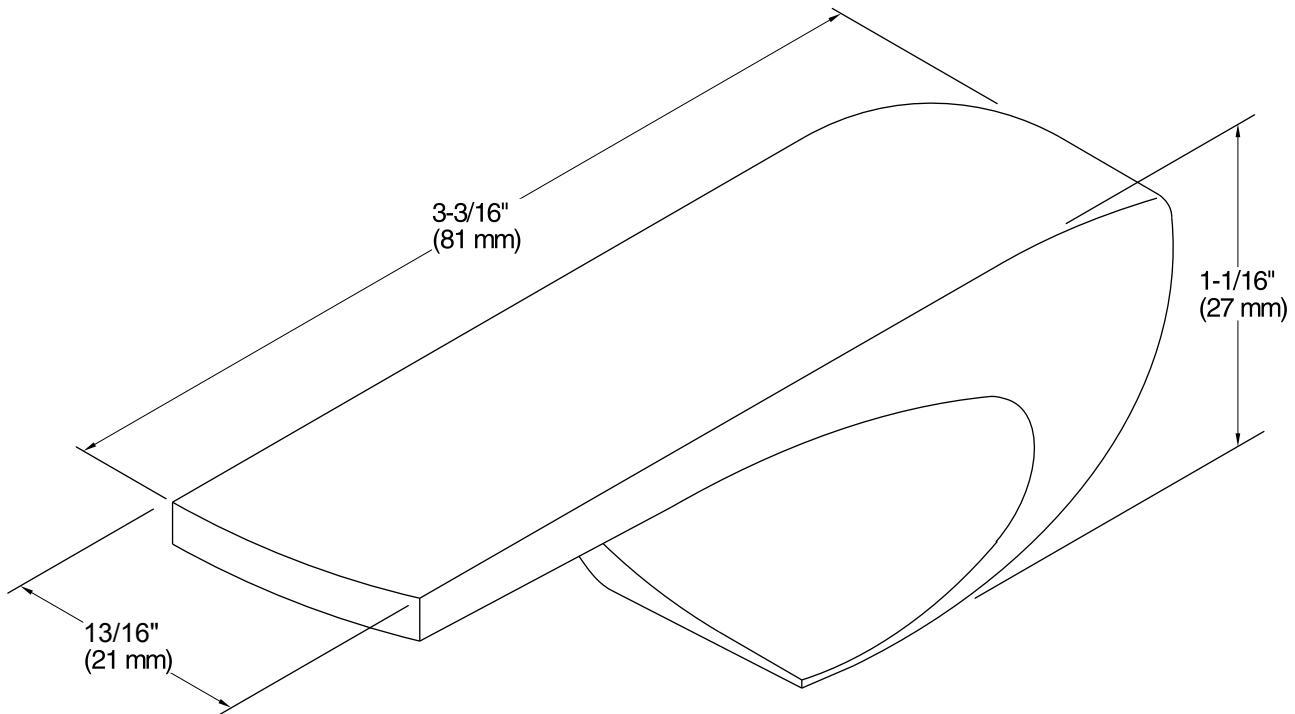

Technical Information

All product dimensions are nominal.

Notes

ADA, OBC, CSA B651 compliant when installed to the specific requirements of these regulations.