



Limited One Year Warranty

T&S warrants to the original purchaser (other than for purposes of resale) that such product is free from defects in material and workmanship for a period of one (1) year from the date of purchase. During this one-year warranty period, if the product is found to be defective, T&S shall, at its options, repair and/or replace it. To obtain warranty service, products must be returned to...

T&S Brass and Bronze Works, Inc.
Attn: Warranty Repair Department
2 Saddleback Cove
Travelers Rest, SC 29690

Shipping, freight, insurance, and other transportation charges of the product to T&S and the return of repaired or replaced product to the purchaser are the responsibility of the purchaser. Repair and/or replacement shall be made within a reasonable time after receipt by T&S of the returned product. This warranty does not cover items which have received secondary finishing or have been altered or modified after purchase, or for defects caused by physical abuse to or misuse of the product, or shipment of the products.

Any express warranty not provided herein, and any remedy for Breach of Contract which might arise, is hereby excluded and disclaimed. Any implied warranties of merchantability or fitness for a particular purpose are limited to one year in duration. Under no circumstances shall T&S be liable for loss of use or any special consequential costs, expenses or damages.

Some states do not allow limitations on how long and implied warranty lasts or the exclusion or limitation of incidental or consequential damages, so the above limitations or exclusions may not apply to you. Specific rights under this warranty and other rights vary from state to state.

P/N: 098-003111-45 Rev 2
Date: 980309
Drawn: CW
Checked: MAB 9-8-98
Approved: MW 9-3-98

Installation and Maintenance Instructions



BASE FAUCET B-0220, B-0222, B-0320, and B-0321

**Deutsch: Installations- und
Wartungsanleitungen**

**Español: la Instalación y las
Instrucciones de
Mantenimiento**

**Français: les Instructions
d'Installation et
d'Entretien**

Exploded View

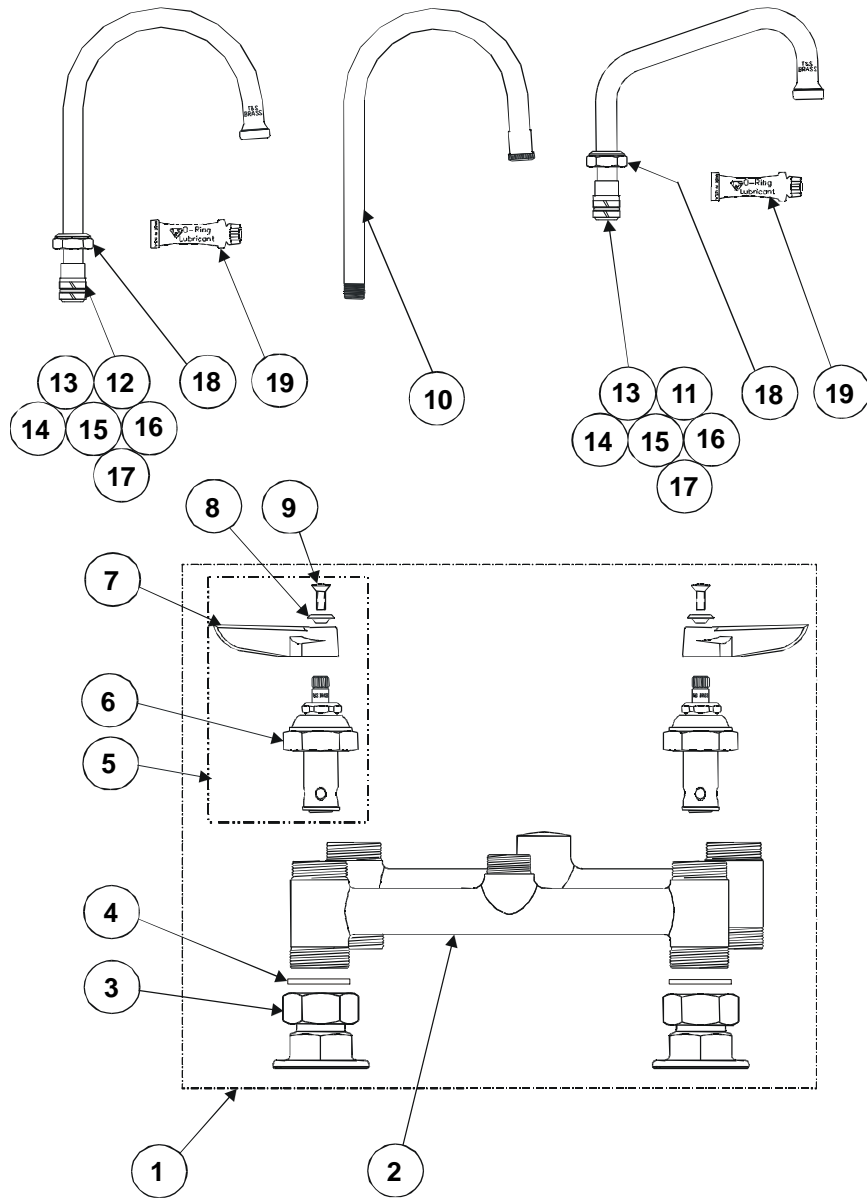

* Some items are listed for instructional purposes and may not be sold as separate parts.

Part Number Guide

Body Faucet Assemblies

1	Asm, Faucet (Rigid)	B-0320-LN
	Asm, Faucet (Swivel)	B-0220-LN
2	Faucet Body (Rigid)	*
	Faucet Body (Swivel)	*
3	Asm, Coupling Flange	002893-40
4	Washer	001019-45
5	Asm, Cartridge	
6	LH, w/Spring Checks	002711-40
	RH, w/Spring Checks	002712-40
	LH, w/o Spring Checks	002713-40
	RH, w/o Spring Checks	002714-40
7	Handle, Lever - Hot	001637-45
	Handle, Lever - Cold	001636-45
8	Index, Button	
	Hot (Red)	001661-45
	Cold (Blue)	001660-45
9	Screw, Handle	000922-45

Nozzle Assemblies

10	Asm, Gooseneck Nozzle	120X
11	Asm, Nozzle Swing	
	Nozzle, 6"	059X
	Nozzle, 12"	062X
	Nozzle, 18"	065X
12	Asm, Gooseneck, w/Swing	133X
13	Swivel Piece	*
14	Washer, Swivel Piece	*
15	Repair Kit	011643-45
16	Sleeve, Swivel	*
17	"O"-Ring	*
18	Nut, Swivel	*
19	Grease Tube	010573-45

General Instructions

Nozzle Installation:

Note: Nozzles should be installed first.

If installing Rigid Gooseneck

1. Apply teflon tape or pipe joint compound to threaded end of no.9.
2. Tighten no.9 firmly by hand into no.1.

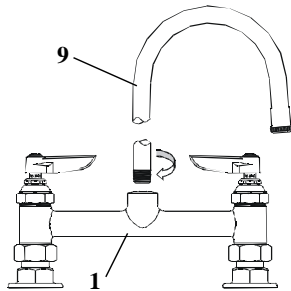

If installing Swing Nozzle

3. Insert no.11 or no.12 into no.1 and rotate to front of sink.
4. Tighten no.11 firmly with a wrench.

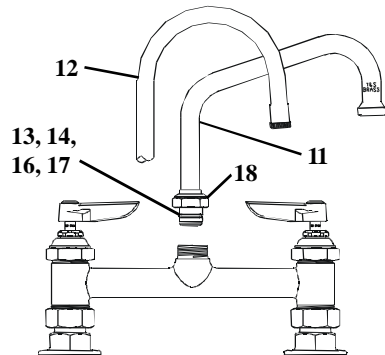

For swivel repair or replacement of ('o'-ring) no.17 and (sleeves) no.16.

5. Insert one no.16 onto no.13. Install no.17 on no.13 and lubricate liberally with provided no.19. Install second no.16 onto no.13. (See enlarged view)

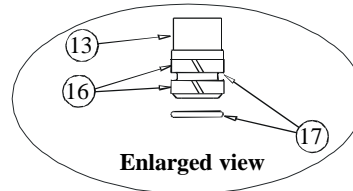

Faucet Installation:

6. Shut off water supply and drain lines. Drill (2) two holes, approximately 1-1/4" diameter in countertop with 8" centers, where you are installing no.1.

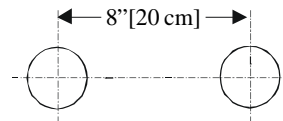

7. Apply teflon tape or pipe joint compound to water supply lines.

8. Connect no.1 to water supply lines by screwing no.2 (with eccentric centers) onto nipple (supplied by others) and tightening no.2 against countertop. (Nut under countertop to be supplied by others). Trim supply lines if necessary.

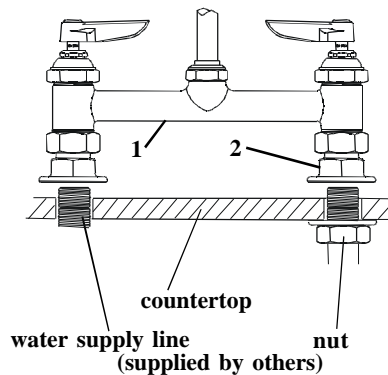

9. Turn on water supply and check for leaks.

Instrucciones Generales

Instalación de la boquilla:

Nota: Las boquillas deben de ser instaladas primero.

Instalación de la boquilla rígida de cuello de cisne

1. Aplique al extremo con rosca de la parte No.9 cinta para rosca de tubería o compuesto de coyuntura.
2. Apriete firmemente a mano la parte No.9 entre la parte No.1.

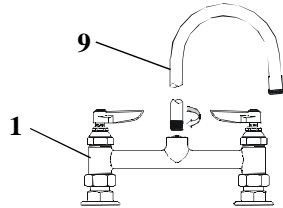

Si esta instalando boquilla oscilar

3. Inserte la parte No.11, o No.12 en la parte No.1 y gire hacia el frente del lavatorio.
4. Apriete firmemente la parte No.11 con una llave.

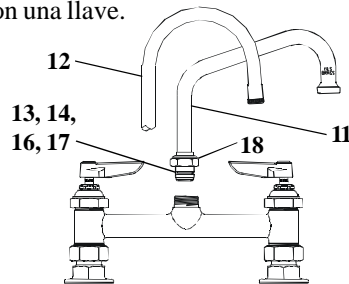

Para el reparo del eje giratorio o reemplazo de (argolla de goma) parte No.17 y (manga) No.16.

5. Inserte la parte No.16 en la parte No.13. Instale la parte No.17 en la parte No.13 y lubrique liberalmente con la parte No.19 surtida. Instale la segunda parte No.16 en la parte No.13. (Vea el dibujo ampliado)

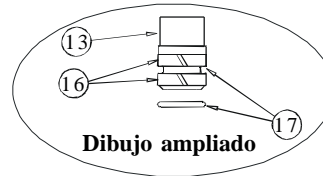

Instalación de la canilla:

6. Cierre la fuente principal de agua y desagüe las tuberías. Perfore dos huecos aproximadamente de 3 cm de diámetro en el mostrador, con centros de 20 cm, donde la parte No.1 será instalada.

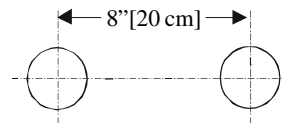

7. Aplique cintas para rosca de tubería o compuesto de coyuntura a las líneas del surtido de agua.

8. Conecte la parte No.1 a las líneas del surtido de agua atornillando la parte No.2 (con los lados excéntricos) en los tubos (surtidos por otros) y apriete la parte No.2 contra el mostrador. (La tuerca debajo del mostrador esta surtida por otros). Si es necesario corte las líneas de surtido.

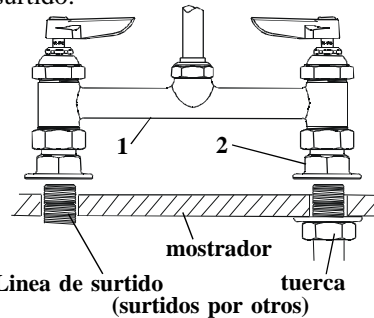

9. Abra la fuente de agua e inspeccione por filtraciones.

Instructions Générales

L'Installation De L'Ajutage

Noter: Les ajutages doivent être installés au début

Si vous installez l'ajutage col-de-cygne

1. Appliquer le ruban en Téflon ou le composé pour les tuyaux à l'extrémité de N° 9.
2. Resserrer N° 9 fermement par la main dans N° 1.

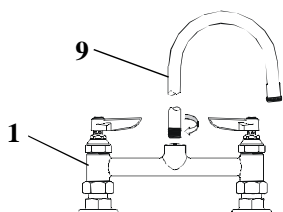

Si vous installez l'ajutage pivotant

3. Insérer N° 11 ou N° 12 dans N° 1 et le tourner jusqu'à la face de l'évier.
4. Resserrer N° 11 fermement avec une clef.

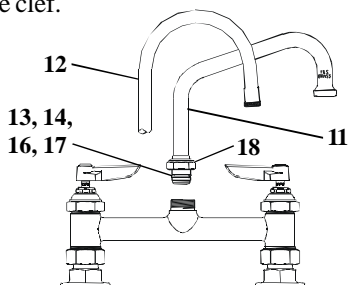

Pour la réparation de l'ajutage pivotant ou le remplacement de (l'anneau o) N° 17 et (les manches) N° 16

5. Insérer un N° 16 sur N° 13. Installer N° 17 sur N° 13 et lubrifier libéralement avec le N° 19 fourni. Installer l'autre N° 16 sur N° 13. (Voir la vue agrandie).

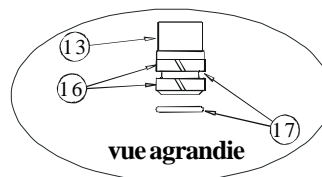

L'installation du robinet

6. Fermer la réserve de l'eau et égoutter la tuyauterie. Percer deux (2) trous avec un diamètre environ 3 cm. dans le comptoir avec des centres de 20 cm où vous allez installer N° 1.

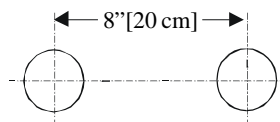

7. Appliquer le ruban en Téflon ou le composé pour les tuyaux aux tuyaux qui fournissent l'eau.

8. Brancher N° 1 aux tuyaux qui fournissent l'eau en vissant N° 2 avec les centres excentriques sur le raccord (fourni par les autres) et resserrer N° 2 contre le comptoir. (L'écrou au-dessous du comptoir fourni par les autres). Couper un peu les tuyaux qui fournissent l'eau si nécessaire.

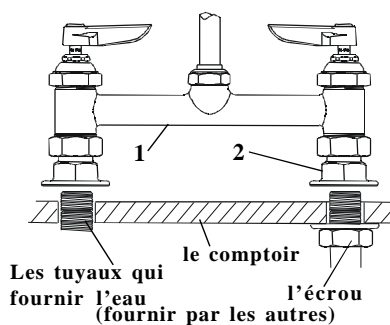

9. Recommencer l'eau et vérifier s'il y a des fuites.

Allgemeine Anleitungen

Installation des Schwenkarms:

Hinweis: Schwenkarme sind als erstes zu installieren.

Falls der feststehende Gußauslauf installiert wird

1. Auf das Gewindeteil von Nr. 9 Teflonband oder Rohrkitt auftragen.
2. Nr. 9 fest mit der Hand in Nr. 1 einschrauben.

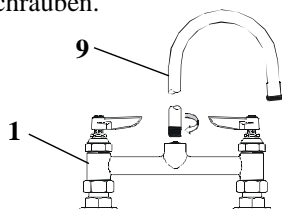

Falls Schwenkarm installiert wird

3. Nr. 11 oder Nr. 12 in Nr. 1 einfügen, auf dem Spültisch nach vorne drehen.
4. Nr. 11 mit Schraubenschlüssel festdrehen.

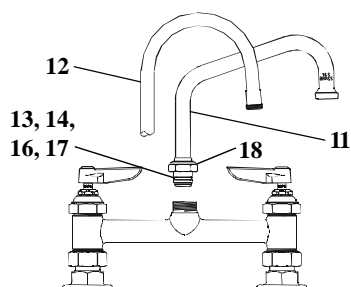

Zum Reparieren des Schwenkarms oder Ersetzen von Nr. 17 (O-Ring) und Nr. 16 (Muffen):

5. Eine Nr. 16 auf Nr. 13 aufschieben. Nr. 17 auf Nr. 13 installieren und mit mitgelieferter Nr. 19 gut schmieren. Die zweite Nr. 16 auf Nr. 13 installieren. (Siehe vergrößerte Ansicht.)

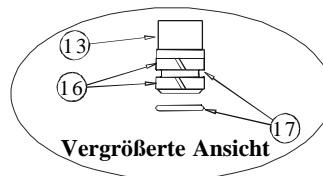

Installation des Wasserhahns:

6. Wasser abdrehen und Wasserleitungen entleeren. Zwei Löcher mit einem Durchmesser von 3 cm und einem Abstand von 20 cm in die Deckplatte bohren, in die Nr. 1 installiert wird.

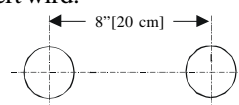

7. Teflonband oder Rohrkitt auf Wasserleitungsrohre auftragen.

8. Nr. 1 an Wasserleitung anschließen, indem Nr. 2 (mit versetzter Mitte) auf den Nippel (nicht in der Lieferung enthalten) aufgeschraubt und gegen die Deckplatte festgezogen wird. (Mutter auf der gegenüberliegenden Deckplatte nicht in der Lieferung enthalten.) Falls erforderlich, Wasserleitungen entsprechend kürzen.

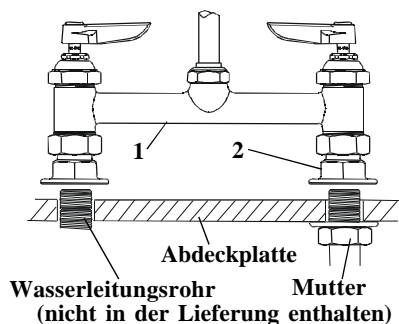

9. Wasser andrehen und auf Dichtigkeit prüfen.

RELATED T&S BRASS PRODUCT LINE



**B-0245
Deck Mixing Faucet
with 18" Double
Swing Joint Nozzle**

T&S BRASS AND BRONZE WORKS, INC.

A firm commitment to application-engineered plumbing products

2 Saddleback Cove, P.O. Box 1088,
Travelers Rest, SC 29690

Phone: (864) 834-4102
Fax: (864) 834-3518

E-mail: tsbrass@tsbrass.com

T & S Brass-Europe
'De Veenhoeve'
Oude Nieuwveenseweg 84
2441 CW Nieuwveen
The Netherlands

