

#### Features

- Single-speed whirlpool offers performance and value with 8 fully adjustable jets.
- Hydromassage flow and direction can be controlled at each jet.
- Integral lumbar support and armrests offer extra comfort while bathing.
- Integral apron.
- Integral flange helps prevent water from seeping behind wall and simplifies alcove installation.
- Textured bottom surface.
- Coordinates with other products in the Devonshire collection.

#### Material

- Acrylic.

#### Hydrotherapy

- Whirlpool.

#### Installation

- Right drain.
- Alcove.

#### Recommended Products/Accessories

- K-7161-AF 1-1/2" adjustable pop-up drain above- or through-floor
- K-24916 Wireless Music Kit
- K-7213 27" Cable Bath Drain
- K-7214 27" Cable Bath Drain
- K-7259 Brass toe tap bath drain
- K-37380 30" Rough-in Cable Bath Drain
- K-37383 Rough-in cable bath drain, PVC, 30" cable with tubing
- K-702200-G73 Frameless Sliding Bath Door
- K-702200-L Frameless Sliding Bath Door
- K-1491 Bath/Whirlpool Pillow
- K-1601 Bath/whirlpool footstop, removable
- K-23726 Drain treatment
- K-23732 Tub & shower cleaner
- K-702200-6L Frameless sliding bath door
- K-702204-6L Frameless bath door



#### Codes/Standards



ASME A112.19.7/CSA B45.10  
CSA B45.5/IAPMO Z124  
ASTM E162  
ASTM E662  
UL 1795  
CSA C22.2 No. 218.2

#### KOHLER® Hydrotherapy Components Five-Year Limited Warranty

See website for detailed warranty information.

#### Available Colors/Finishes

*Color tiles intended for reference only.*

Color	Code	Description
	0	White
	96	Biscuit
	NY	Dune

No change in measurements if connected with drain illustrated. (K-7161-AF)

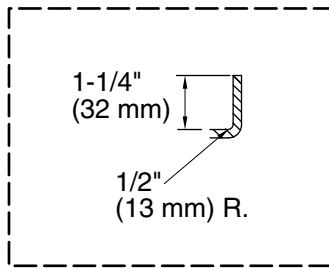

Integral Flange Detail

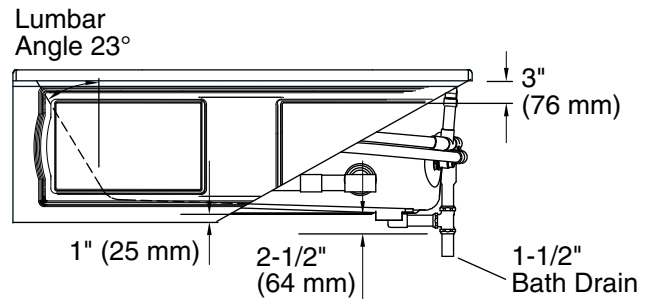
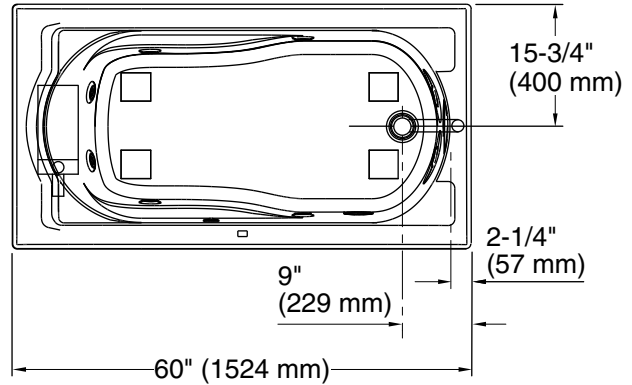
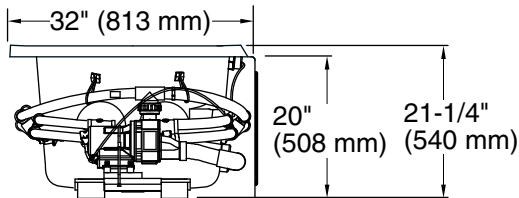

### Required Electrical Service

One dedicated circuit required, protected with Class A Ground-Fault Circuit-Interrupter (GFCI). Outside North America, this device may be known as a Residual Current Device (RCD).

Pump: 120 V, 15 A, 50/60 Hz

### Technical Information

All product dimensions are nominal.

Installation: Three-wall alcove

Drain location: Right

Basin area, bottom: 42" x 20" (1067 mm x 508 mm)

Basin area, top: 51" x 24" (1295 mm x 610 mm)

Weight: 135 lbs (61.2 kg)

Minimum floor load: 50 lbs/ft<sup>2</sup> (244.1 kg/m<sup>2</sup>)

Water depth: 14" (356 mm)

Water capacity: 60 gal (227.1 L)

Electrical component rating: Pump: 120 V, 7 A, 60 Hz

### Notes

Measure your actual product for rough-in details.

Install this product according to the installation instructions.

The hot water supply should be 70% of the capacity of the bath or greater. Installations will vary.