

Maris Undermount Sink - MAG11029-OYS-S | 125.0687.245

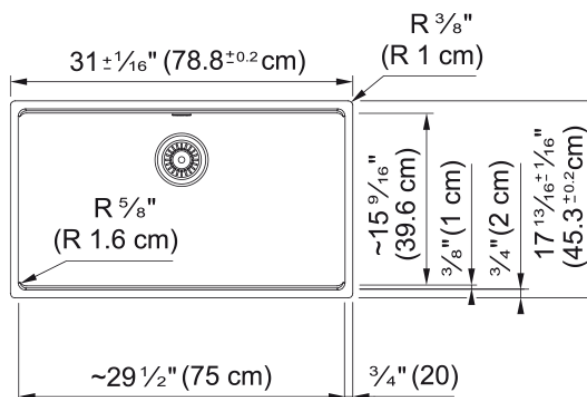

Technical Data

Aspect

Sink type	Sink
Type of material	Granite
Number of bowls	1
Color	Oyster
Surface finish	None

Product Dimensions

Exterior size: right to left	31.008
Exterior size: front to back	17.843
Large bowl size: right to left	29.449
Large bowl size: front to back	15.512
Large bowl: depth	9.488

Installation

Minimum cabinet size	33"
----------------------	-----

Product specifications

Installation type	Undermount
Drain hole	3 1/2"
Position of drainer	No drainer

Product identification

Product brand	FRANKE
Product family	Maris
Collection	Maris
Certified by	IAPMO

Features

Drainers number	No drainer
Product reversibility	No
Faucet ledge	No
Strainer assembly included	Yes

Strainer assembly type	Manual
Overflow	No
Number of faucet holes	No faucet hole
Soap dispenser hole	No