

# Maris Topmount Sink - MAG61029-MOC | 114.0687.101

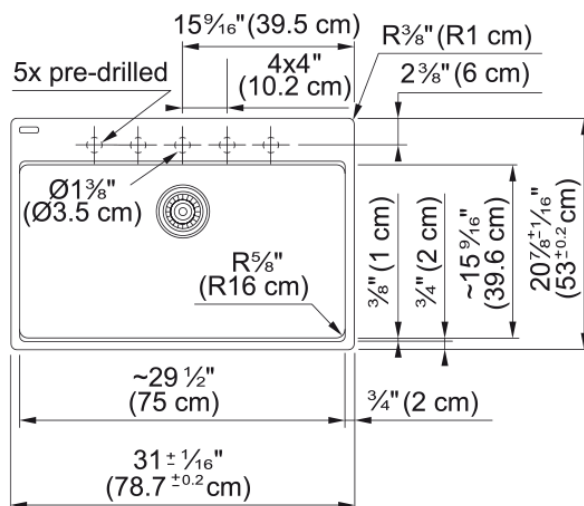

## Technical Data

### Aspect

Sink type	Sink
Type of material	Granite
Number of bowls	1
Color	Mocha
Surface finish	None

### Product Dimensions

Exterior size: right to left	31
Exterior size: front to back	20.874
Large bowl size: right to left	29.449
Large bowl size: front to back	15.512
Large bowl: depth	9.488

### Installation

Minimum cabinet size	33"
----------------------	-----

### Product specifications

Installation type	Topmount / drop in
Drain hole	3 1/2"
Position of drainer	No drainer

### Product identification

Product brand	FRANKE
Product family	Maris
Collection	Maris
Certified by	IAPMO

### Features

Drainers number	No drainer
Product reversibility	No
Faucet ledge	Yes
Strainer assembly included	No

Strainer assembly type	No waste kit
Overflow	No
Number of faucet holes	5 - pre-scored
Soap dispenser hole	No