

Maris Topmount Sink - MAG61031-SHG | 114.0686.986

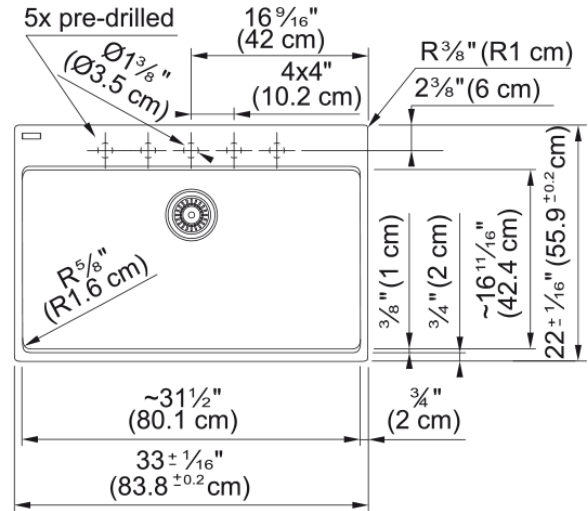

Technical Data

Aspect

Sink type	Sink
Type of material	Granite
Number of bowls	1
Color	Stone grey
Surface finish	None

Product Dimensions

Exterior size: right to left	33
Exterior size: front to back	22.008
Large bowl size: right to left	31.457
Large bowl size: front to back	16.614
Large bowl: depth	9.488

Installation

Minimum cabinet size	36"
----------------------	-----

Product specifications

Installation type	Topmount / drop in
Drain hole	3 1/2"
Position of drainer	No drainer

Product identification

Product brand	FRANKE
Product family	Maris
Collection	Maris
Certified by	IAPMO

Features

Drainers number	No drainer
Product reversibility	No
Faucet ledge	Yes
Strainer assembly included	No

Strainer assembly type	No waste kit
Overflow	No
Number of faucet holes	5 - pre-scored
Soap dispenser hole	No