

Maris Topmount Sink - MAG6601812LD-SHG | 114.0687.014

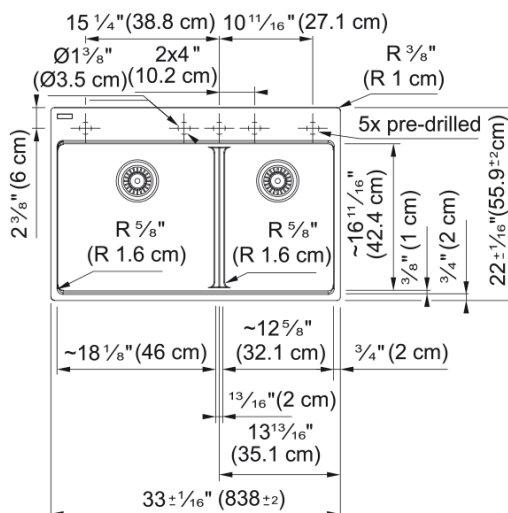
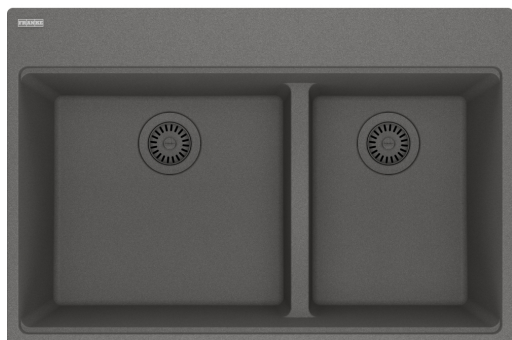

Technical Data

Aspect

Sink type	Sink
Type of material	Granite
Number of bowls	2
Color	Stone grey
Surface finish	None

Product Dimensions

Exterior size: right to left	32.992
Exterior size: front to back	22.008
Large bowl size: right to left	18.15
Large bowl size: front to back	16.614
Large bowl: depth	9.488
Small bowl size: right to left	12.756
Small bowl size: front to back	16.614
Small bowl: depth	9.488

Installation

Minimum cabinet size	33"
----------------------	-----

Product specifications

Installation type	Topmount / drop in
Drain hole	3 1/2"
Position of drainer	No drainer

Product identification

Product brand	FRANKE
Product family	Maris
Collection	Maris
Certified by	IAPMO

Features

Drainers number	No drainer
-----------------	------------

Product reversibility	No
Faucet ledge	Yes
Strainer assembly included	No
Strainer assembly type	No waste kit
Overflow	No
Number of faucet holes	5 - pre-scored
Soap dispenser hole	No