

Steel Queen Drop In Sink QSL2020-10-3N | 101.0651.338

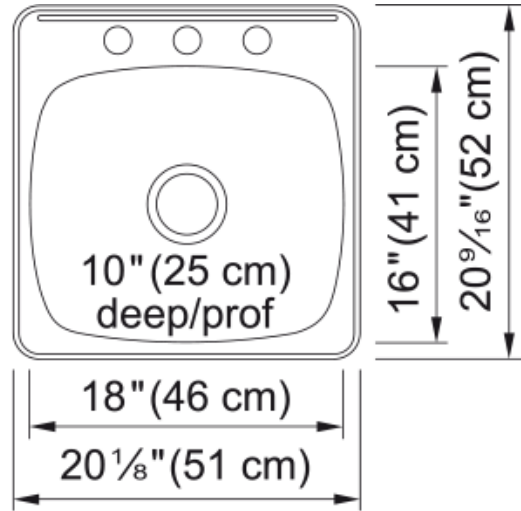

Technical Data

Aspect

Sink type	Sink
Type of material	Stainless steel
Number of bowls	1
Color	Steel
Surface finish	High gloss

Product Dimensions

Exterior size: right to left	20
Exterior size: front to back	20.5
Large bowl size: right to left	18.02
Large bowl size: front to back	16
Large bowl: depth	10

Installation

Minimum cabinet size	24"
----------------------	-----

Product specifications

Installation type	Topmount / drop in
Drain hole	3 1/2"
Position of drainer	No drainer

Product identification

Product brand	Kindred
Collection	Steel Queen
Certified by	CSA

Features

Drainers number	No drainer
Product reversibility	No
Faucet ledge	Yes
Strainer assembly included	No
Strainer assembly type	No waste kit

Overflow	No
Number of faucet holes	3
Soap dispenser hole	No