

# BRIZO®

## BATHROOM FAUCET

- Invari® Collection
- Single Handle Two Hole Wall Mount

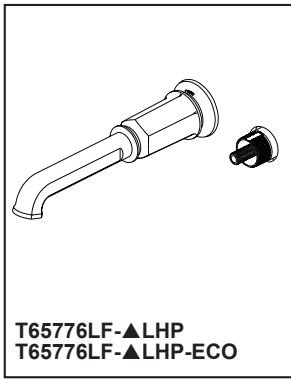

### STANDARD SPECIFICATIONS:

- Max flow rate 1.5 gpm @ 60 psi, 5.7 L/Min @ 414 kPa
- Max flow rate (ECO models only) 1.2 gpm @ 60 psi, 4.5 L/Min @ 414 kPa
- Control mechanism - 28 mm ceramic mixing cartridge with metal stem and 180° rotation
- Spout features laminar water efficient flow
- Solid brass fabricated body
- Drain sold separately
- Rough-in R85800 required for installation, not included
- Optional 9 1/2" (241 mm) escutcheon - RP100323▲ (not included)
- LHP - Less Handle Program. See handle options below

### WARRANTY







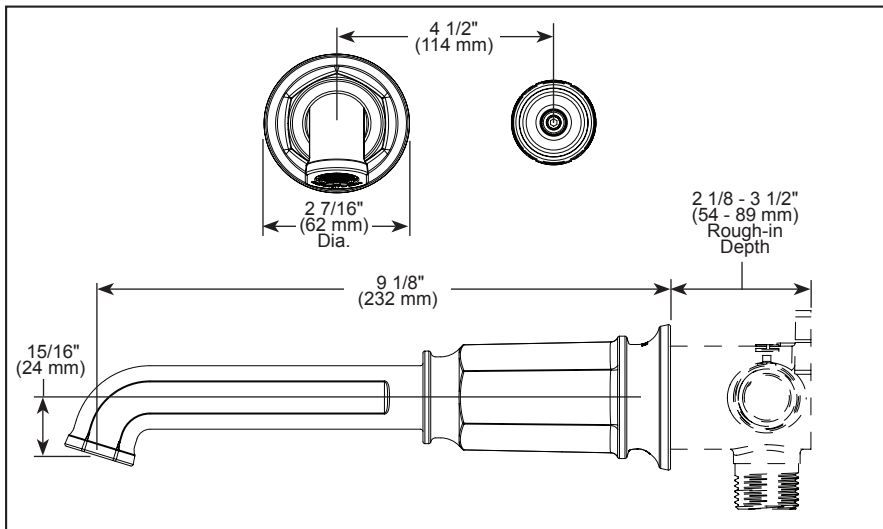

- Parts and Finish - Lifetime limited warranty; or for commercial purchasers, 10 years for multi-family residential (apartments and condominiums) and 5 years for all other commercial uses, in each case from the date the product is received by the original purchaser or their authorized representative (installation contractor, etc.).
- Electronic Parts and Batteries (if applicable) - 5 years from the date the product is received by the original purchaser or their authorized representative (installation contractor, etc.); or for commercial purchasers, 1 year from the date the product is received by the original purchaser or their authorized representative (installation contractor, etc.). No warranty is provided on batteries.
- Please go to [www.brizo.com](http://www.brizo.com) for the complete details of our limited warranty.

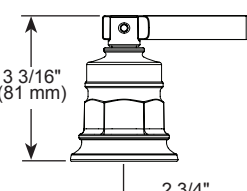

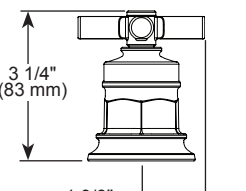
### COMPLIES WITH:

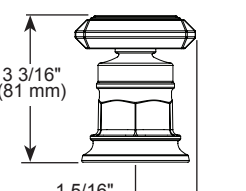
- ASME A112.18.1 / CSA B125.1
- ASME A112.18.2 / CSA B125.2
- EPA WaterSense®
- ICC/ANSI A117.1 - Valve control only

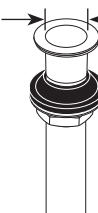

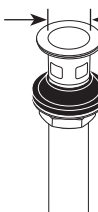
<p><b>HL5876-▲</b> </p>  <p>3 3/16" (81 mm) 2 3/4" (70 mm)</p>	<p><b>HX5876-▲</b> </p>  <p>3 1/4" (83 mm) 1 3/8" (35 mm)</p>	<p><b>HL5876-▲</b> </p>  <p>3 3/16" (81 mm) 1 5/16" (33 mm)</p>
<p><b>RP72411▲</b> Grid Strainer Drain less overflow holes</p> 	<p><b>RP72413▲</b> Push Button Drain less overflow holes</p>  <p>2 3/4" (70 mm) Dia.</p>	<p><b>RP81627▲</b> Push Button Drain less overflow holes</p>  <p>1 5/8" (41 mm) Dia.</p>
<p><b>RP72412▲</b> Grid Strainer Drain with overflow holes</p> 	<p><b>RP72414▲</b> Push Button Drain with overflow holes</p>  <p>2 3/4" (70 mm) Dia.</p>	<p><b>RP81628▲</b> Push Button Drain with overflow holes</p>  <p>1 5/8" (41 mm) Dia.</p>

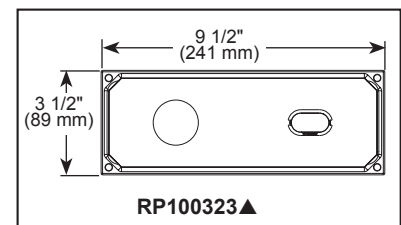

▲Designate Finish Suffix

Brizo reserves the right (1) to make changes in specifications and materials, and (2) to change or discontinue models, both without notice or obligation. Dimensions are for reference only. See current full-line price book or [www.brizo.com](http://www.brizo.com) for finish options and product availability.

BSP-L-T65776LF-LHP Rev. E

**Brizo Kitchen & Bath Company**  
55 E. 111th Street, Carmel, Indiana 46280  
350 South Edgeware Road, St. Thomas, ON N5P 4L1  
© 2024 Brizo Kitchen & Bath Company