



# Electronic Exposed TECK® II Flush Valves (with H2Optics®)

Record model number:

**81T2 1 A - - MMO**

**Valve Type**  
0 = W/C (Water Closet)  
3 = Urinal

**Power Option**  
BT = Battery  
HW = Hardwired

**Alternate Flush Volumes**  
(leave blank if not applicable)  
42 = 4.2 L (litre) (1.1 gal) fixed flush (W/C only)  
48 = 4.8 L (1.27 gal) fixed flush (W/C only)  
05 = 0.5 L (0.125 gal) fixed flush (Urinal only)

**Manual Mechanical  
Override**

212387

212387

212387

212387

212387

212387

212387

212387

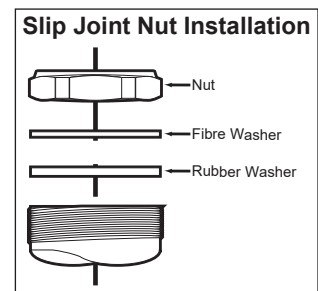
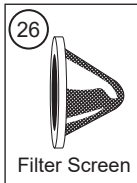
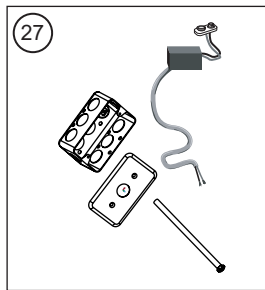
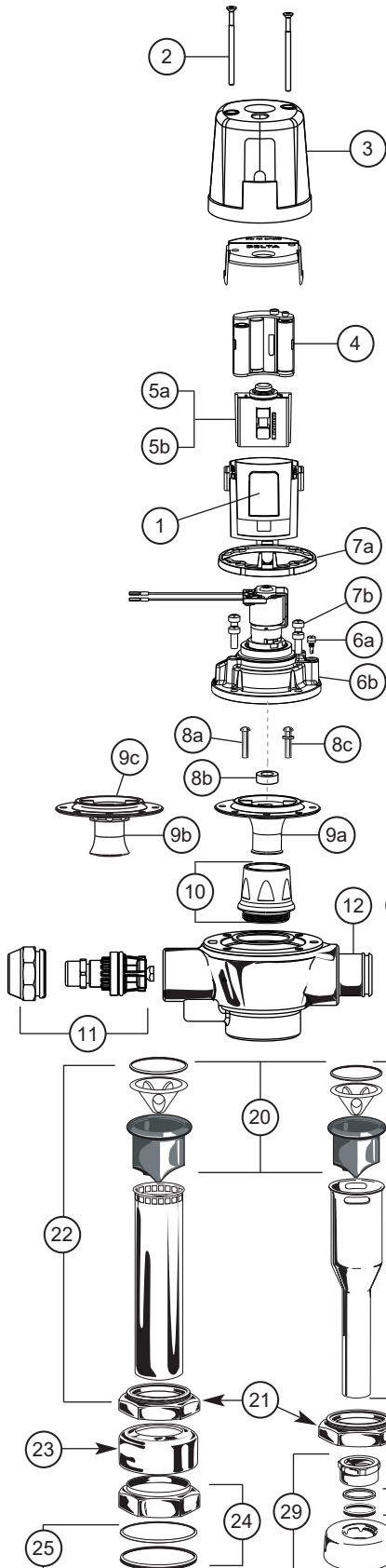

**PLEASE LEAVE this M&I Sheet with the owner, maintenance plumber, etc. as items relating to ongoing maintenance suggestions and procedures are included.**







Item #	Part #	Description
1	061063A	Replaceable Lens for 3rd Generation E-FV
2	061138A *	Cover Screws for 3rd Generation E-FV (2/pkg)
3	061139A	Metal Cover
4	060334A	Battery Holder
5a	061363A	Water Closet Board & Electronic Override Button
5b	061364A	Urinal Board & Electronic Override Button
6a	061024A	Regulating Screw & O-Ring
6b	061353A	Cap/Solenoid & Regulating Screw Assembly for 0.5L (0.125 gal) fixed urinals (see Table 1)
	061354A	Cap/Solenoid & Regulating Screw Assembly for 4.2L (1.1 gal) fixed water closets (see Table 1)
	061355A	Cap/Solenoid & Regulating Screw Assembly for 4.8L (1.27 gal) fixed water closets (see Table 1)
	061356A	Cap/Solenoid & Regulating Screw Assembly for 1.9L (0.5 gal) adjustable urinals (see Table 1)
	061325A	Cap/Solenoid & Regulating Screw Assembly for 6.0L (1.6 gal) adjustable water closets (see Table 1)
7a	061141A *	Cover Gasket (3/pkg)
7b	060078A *	Screws for Cast Cap (4/pkg)
8a	060507A *	Poppet Pin Pack (3/pkg) (see Table 1)
8b	062025A *	Washer (3/pkg) (required for 4.2 & 4.8L Valves only) (see Table 1)
8c	060508A *	Poppet Pin Pack (3/pkg) (0.5L Valves only) (see Table 1)
9a	061323A	Diaphragm/Guide Assembly Complete - W/C (see Table 1)
9b	061324A	Diaphragm Guide Assembly for Urinals (See Table 1)
9c	060079A-MMO	Diaphragm only (12/pkg)
10	062007A	Brass Seat with O-Ring
11	061322A	Push Button, Cage, Cap Nut
12	060506A	Standard Adjustable Tail
13	060735A	Union Nut
14	060692A	Retaining Ring
15	060082A *	Adjustable Tail O-Ring Package (20/pkg)
16	060504A	S/S Wall Flange & Cover Tube
17	060697A	1" Copper Sweat Inlet Adaptor
	060694A	¾" Copper Sweat Inlet Adaptor
	060764A	¾" FIP Inlet Adaptor
18	060843A	Retrofit Check Stem Unit, Capnut & Button Complete
	060844A	Seat Washer, Spring, Button & O-Ring Kit
	060859A	Angle Stop with Union Nut & Tail Complete
19	060081A *	Plug Button Package (12/pkg)
20	060785A	Vacuum breaker sleeve complete
21	060094A	Coupling Ring
22	060782A	1-1/2" x 10" (38 mm x 254 mm) V.B., coupling ring and tube complete
23	060004A	1½" Spud Flange
24	060778A	1½" Rough Coupling Nut & Washers
25	060083A *	1½" Slip Joint Washers (12/pkg)
26	060344A *	Filter Screen Kit (12/pkg)
27	061069A	Hardwire Converter & Rigid Connection Assembly for 3rd Gen E-FV
28	060784A	¾" x 11½" VB, Ring & Tube Complete (Urinal)
29	060463A	¾" Coupling Nut, ¾" Washers & ¾" Spud Flange
30	060049A *	¾" (19mm) Rubber and fiber washers (12/pkg)
	060704A **	Transformer (110 to 24 VAC) for 5 sensor modules
	060771A **	Transformer (110 to 24 VAC) for 10 sensor modules

**NOTE:** Refer to TECK flushometer repair parts and maintenance manual for additional parts and information.

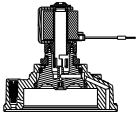
\* Package quantities may change. Check the parts section of the latest Delta Commercial Faucet Price List for current quantities.

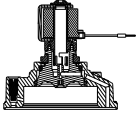
\*\* Each individual sensor module requires its own 24 VAC to 6 VDC hardwire converter.

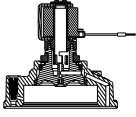
### Table 1 - Cap/Pin/Diaphragm Configuration Table

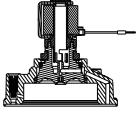
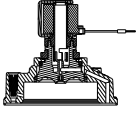
	Flush Volume	Cap/Solenoid & Regulating Screw Assembly (includes Cap, Solenoid, Regulating Screw)	Poppet Pin	Diaphragm Assembly
*UR - Fixed	**0.5L (0.125 gal)	061353A 	060508A 	
UR - Adjustable	1.9L (0.5 gal)	061356A 	060507A 	
*W/C - Fixed	**4.2L (1.1 gal)	061354A 	060507A & 062025A 	
	**4.8L (1.27 gal)	061355A 		
W/C - Adjustable	6.0L (1.6 gal)	061325A 		

**NOTE: Must use all noted components listed in Table 1 to ensure correct flush volumes.**

\* Fixed models have epoxy in the adjustment screw.

\*\* WaterSense® compliant when paired with a WaterSense fixture rated for the same flush volume.

Product #	A	B	C
	Max.	±11mm (7/16")	Min.
All 81T201BTA-MMO/ 81T201HWA-MMO variations*	292mm (11½")	121mm (4¾")	54mm (2.13")
All 81T231BTA-MMO/ 81T231HWA-MMO variations*	330mm (13")	121mm (4¾")	54mm (2.13")

**Flushometer MUST be paired with a fixture of equivalent flush volume.**

**RECOMMENDED WATER SUPPLY:**

W/C - minimum flowing pressure: 25 psi (172 kPa),  
minimum flow rate: 25 gpm (95 lpm)

UR - minimum flowing pressure: 25 psi (172 kPa),  
minimum flow rate: 8 gpm (30 lpm)

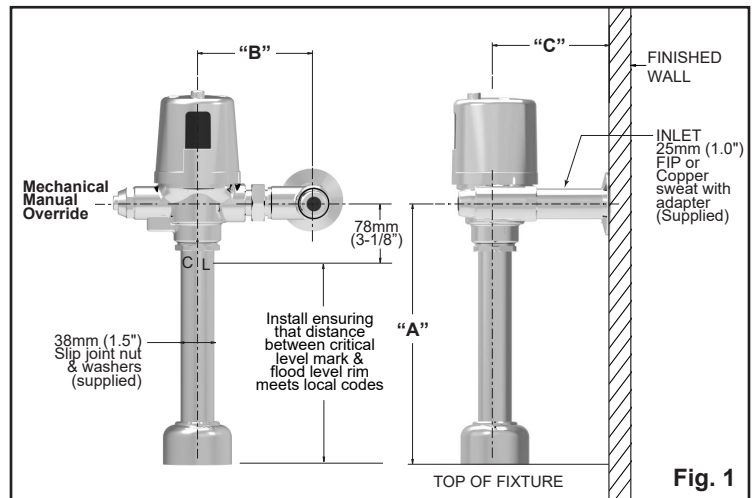

**Fig. 1**