

DF

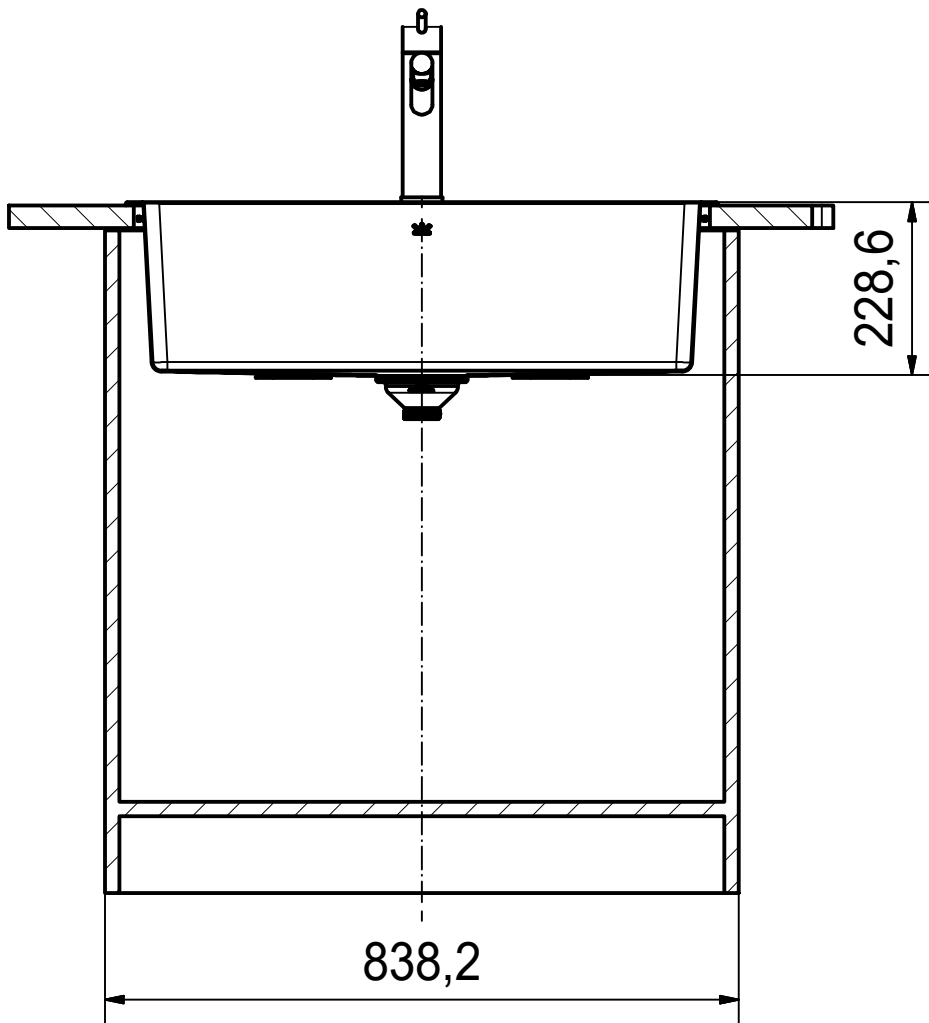

Drawing No.	20191410_01	Revision	-
Drawn Date	05.06.2020		
<small>These drawings and specifications are the property of Franke Technology and Trademark Ltd. and shall not be reproduced, copied or transferred to any third party without the prior written permission of Franke Technology and Trademark Ltd., Hergiswil, Switzerland</small>			

Brookmore 610-29" TL
installing document

Sheet	Sheets
1	6

DS

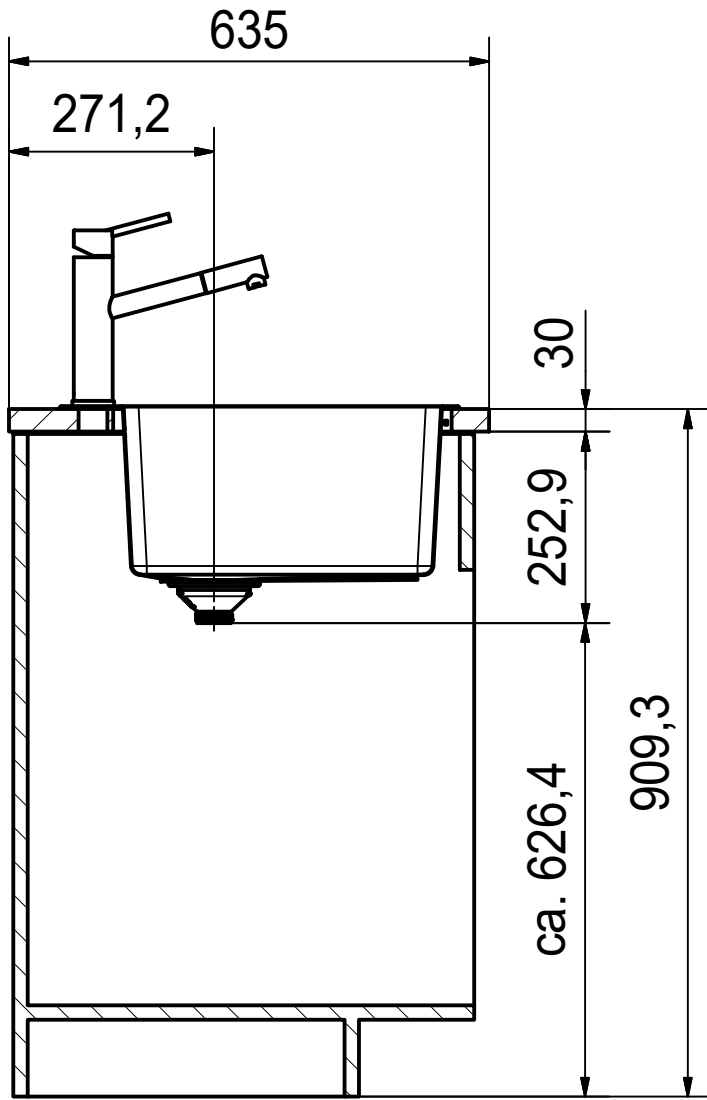

Drawing No.	20191410_01	Revision	-
Drawn Date	05.06.2020		
<small>These drawings and specifications are the property of Franke Technology and Trademark Ltd. and shall not be reproduced, copied or transferred to any third party without the prior written permission of Franke Technology and Trademark Ltd., Hergiswil, Switzerland</small>			

Brookmore 610-29" TL
installing document

Sheet	Sheets
2	6

CO

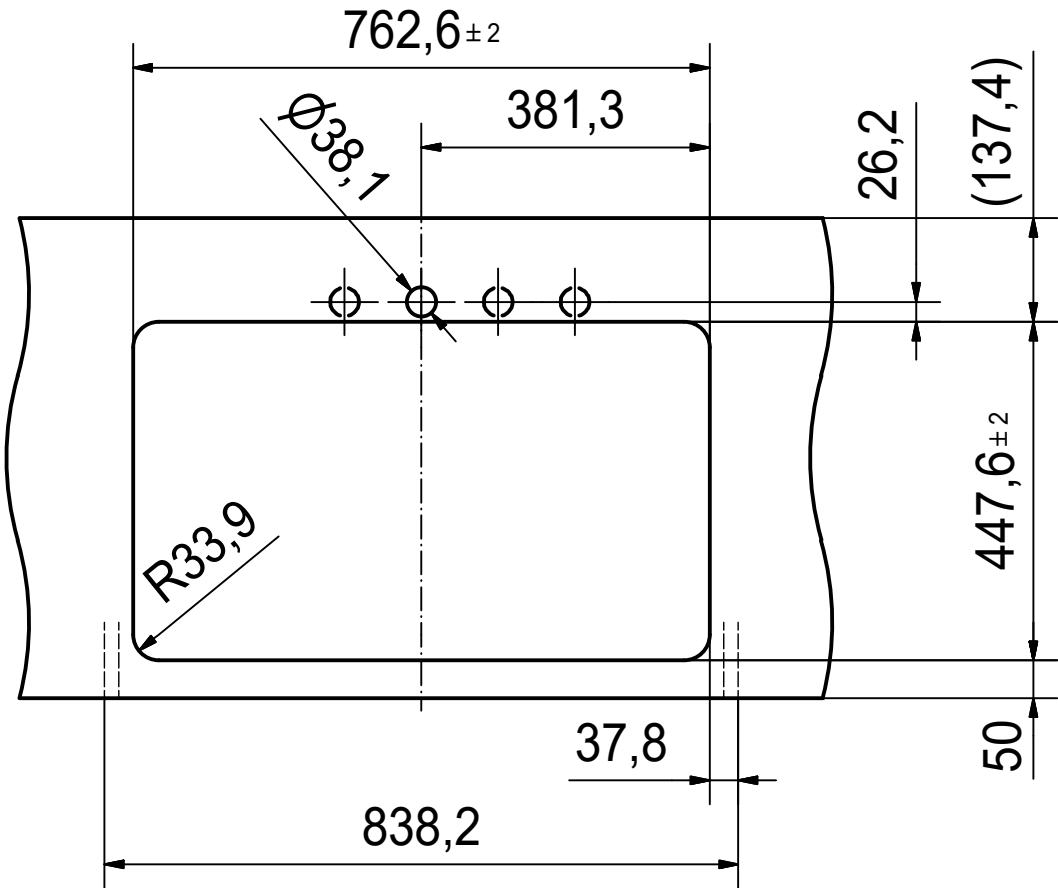

Drawing No.	20191410_01	Revision	-
Drawn Date	05.06.2020		
<small>These drawings and specifications are the property of Franke Technology and Trademark Ltd. and shall not be reproduced, copied or transferred to any third party without the prior written permission of Franke Technology and Trademark Ltd., Hergiswil, Switzerland</small>			

Brookmore 610-29" TL
installing document

Sheet	Sheets
3	6

CNC



Drawing No.	20191410_01	Revision	-
Drawn Date	05.06.2020		
<small>These drawings and specifications are the property of Franke Technology and Trademark Ltd. and shall not be reproduced, copied or transferred to any third party without the prior written permission of Franke Technology and Trademark Ltd., Hergiswil, Switzerland</small>			

Brookmore 610-29" TL
installing document

Sheet	Sheets
4	6

DT

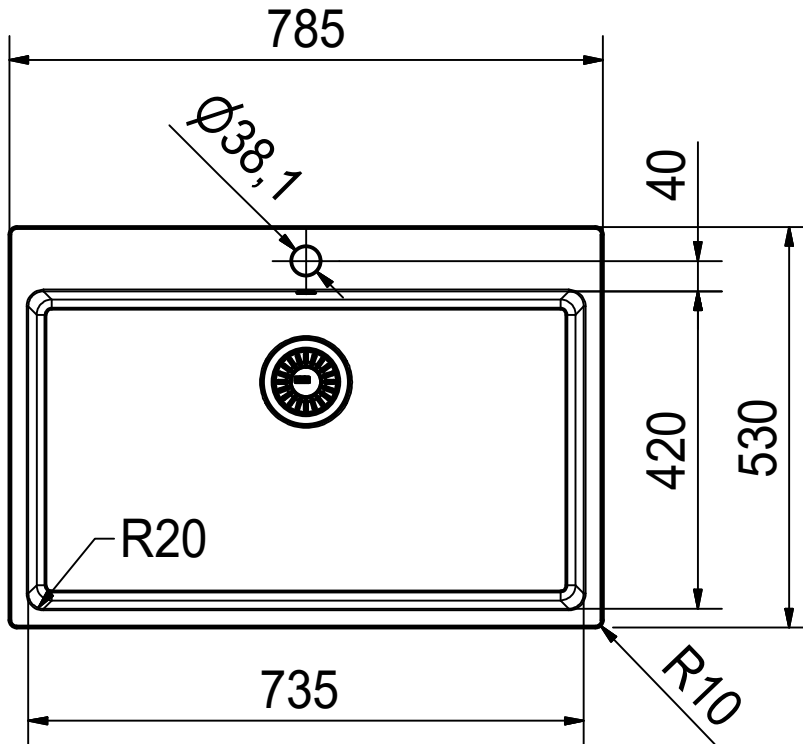

Drawing No.	20191410_01	Revision	-
Drawn Date	05.06.2020		
<small>These drawings and specifications are the property of Franke Technology and Trademark Ltd. and shall not be reproduced, copied or transferred to any third party without the prior written permission of Franke Technology and Trademark Ltd., Hergiswil, Switzerland</small>			

Brookmore 610-29" TL
installing document

Sheet	Sheets
5	6

ISO

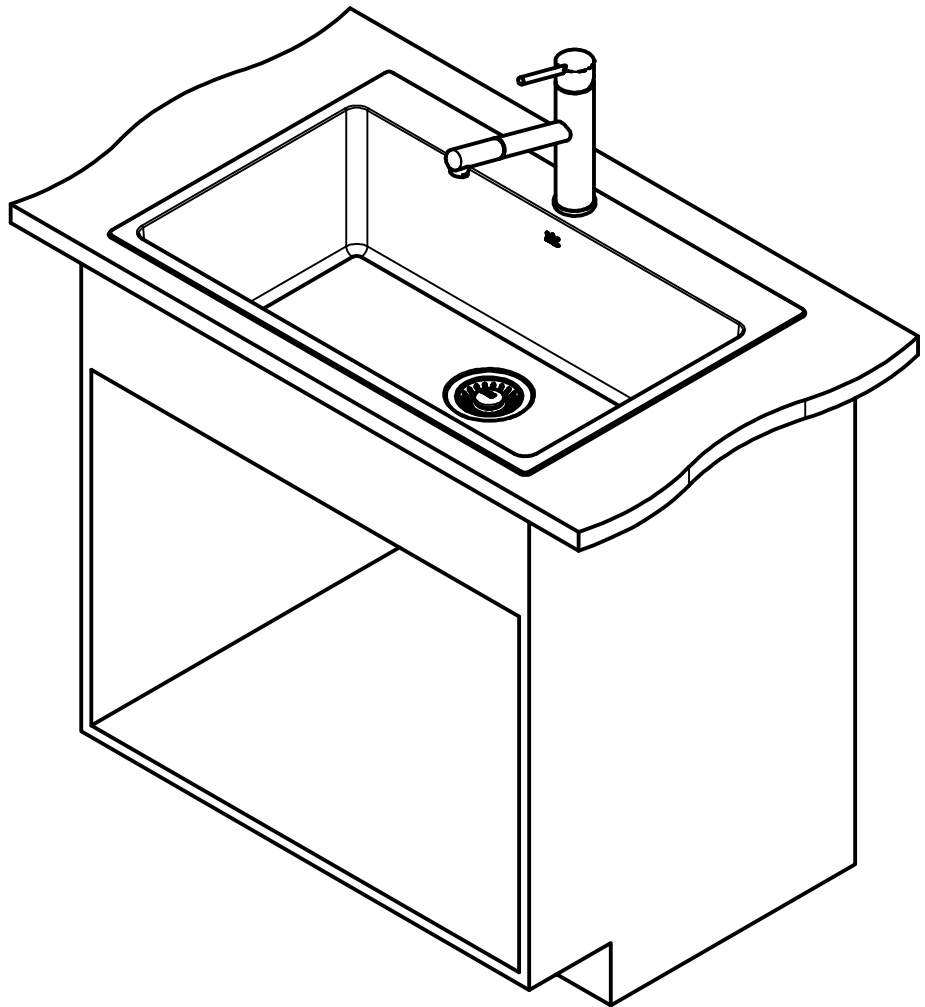

Drawing No.	20191410_01	Revision	-
Drawn Date	05.06.2020		
<small>These drawings and specifications are the property of Franke Technology and Trademark Ltd. and shall not be reproduced, copied or transferred to any third party without the prior written permission of Franke Technology and Trademark Ltd., Hergiswil, Switzerland</small>			

Brookmore 610-29" TL
installing document

Sheet	Sheets
6	6