



**Polypropylene venting products  
for high-efficiency condensing  
appliance installations.  
Chloride free, environmentally safe.  
Listed to ULC-S636.**



# **PolyPro<sup>®</sup>**

**DuraVent**  
Member of  M&G Group

## Specifications

### Applications

PolyPro is a polypropylene vent pipe for use with ANSI Category II and IV gas-burning appliances, including high-efficiency water heaters, condensing boilers and warm air furnaces. PolyPro is listed by Intertek to the ULC S636 standard in Canada as a Class IIA, IIB and IIC vent system suitable for exhaust temperatures up to 230°F / 110°C, and a maximum positive pressure of 15 in-w.c.

### Materials and Construction

Rigid pipe constructed of 2.2mm (minimum) thick polypropylene. Flex is double-wall polypropylene. EPDM or optional Viton Gaskets

### Clearances

0" clearance to combustibles for exhaust temperatures up to 194°F / 90°C, and 0" clearance for vertical installations up to exhaust temperatures of 230°F / 110°C and ¼" / 6mm clearance to combustibles for horizontal installations at exhaust temperatures up to 230°F / 110°C. PolyPro concentric vent system components, including concentric Horizontal Termination and Vertical Termination, are listed at 0" clearance to combustibles for exhaust temperatures up to 230°F / 110°C.

### Diameters

2" (60mm), 3" (80mm), 4" (100mm), 5" (130mm), 6" (150mm), and 8" (200mm).

### Listings

Listed with the appliance in the USA and Canada, check with appliance manufacturer. Intertek / ETL listed to ULC S636 Listed as a Class IIA, IIB, and IIC vent system.

PolyPro complies with LEED® credit IEQc4.1 on VOC limits.

PolyPro is approved by the Massachusetts Plumbers Board. Approval code G1-0811-42.



### PolyPro

PolyPro and PVC/CPVC: PVC pipes are commonly used for venting water heaters, condensing boilers and warm air furnaces, yet PVC was never designed for such use. An environmentally safe and engineered alternative for condensing gas appliances is PolyPro. Engineered for venting, it is 100% recyclable; contains no toxic or carcinogenic materials, chlorides, or heavy metals; and is also easier and faster to install than PVC, saving the contractor time and money. PolyPro does not release hazardous gases during combustion and has been used safely throughout Europe since the early 1990s. Polypropylene has a higher operating temperature limit of 230°F/110°C (PVC is 149°F/65°C max and CPVC is 194°F/90°C). PolyPro is engineered with a corrosion-free, condensation management system.

### PolyPro Flex

PolyPro Flex through B Vent as a Chase: Retrofit venting for new, high-efficiency appliances. When replacing a mid-efficiency appliance with a new condensing 90+ appliance, you can use the existing B vent (any brand) as a chase for the new appliance with PolyPro. The perfect solution for utilizing the B Vent already in place, use the convenient pull cone to insert double-wall PolyPro Flex through the B Vent pipe and terminate in either a two pipe or single pipe system. At the other end is the unique B Vent/PolyPro Support Cap, allowing for the connection of flex to rigid PolyPro lengths and elbows to finish the installation.

### Terminations

DuraVent's concentric PolyPro vertical terminations are lab tested to handle harsh weather and remain icicle free in freezing temperatures. Air circulation and weather conditions like rain, wind and ice have the potential to reduce the efficiency of a unit's performance and the operation of its venting system.



# PolyPro

M&G DuraVent is dedicated to one thing: focusing on the design and manufacture of venting products. As experts in this industry, our team is passionate about creating innovative, quality products. We invest in equipment with the latest technology to develop and test venting products that are engineered to one standard: excellence. All measuring equipment is calibrated to the same levels as used by testing agencies and are compliant with ISO 17025, the test-laboratory standard.

## Wind Tunnel Laboratory

The wind tunnel lab allows us to gather precise data with 270 degrees of measurement on terminations. All data is analyzed for product performance under rigorous conditions before going to market.

## Rain Testing

M&G labs test the vapor/moisture barrier of products by subjecting them to extreme rain and wind conditions. These tests are compliant with both the US and Canadian requirements as well as the stringent European standards.

## Climate Testing

M&G labs have developed a patented ice testing system in the climate room. Tests run to -4°F (-20°C). PolyPro vertical terminations are engineered to remain icicle free.

## Commercial and OEM Product Development

M&G DuraVent engineers are expertly skilled to develop venting components to OEM specs. To satisfy specific venting requirements, DuraVent has the experience to provide custom design, prototyping and testing of vent systems and components engineered to the demands of specific appliances.

**Fast**.....Lightweight and designed for quick and easy assembly.

**Safe**.....no sharp metal edges.

**Clean**.....no corrosion of metals or chlorides.

**Sustainable**.....corrosive condensate resistant and 100% recyclable.

## The PolyPro Commercial Difference

- Available in 5in. (130mm), 6in. (150mm) and 8in. (200mm) diameter.
- Completely smooth inner wall for optimal flow performance.
- Components designed for complete discharge of condensate.
- Design allows for system distance adjustment from the back of the appliance.
- Sizing services available to help in calculating required vent size.



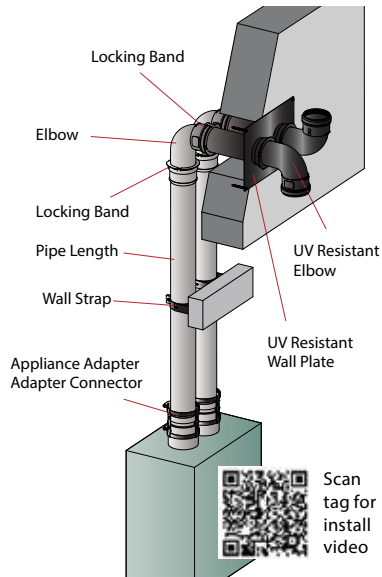

**Horizontal Twin Pipe Elbow Termination**

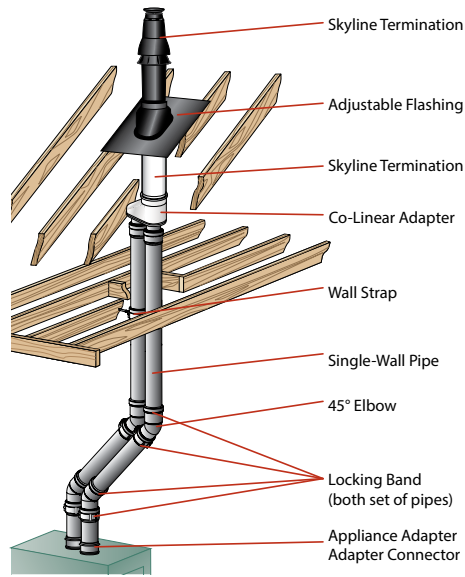

**Vertical**

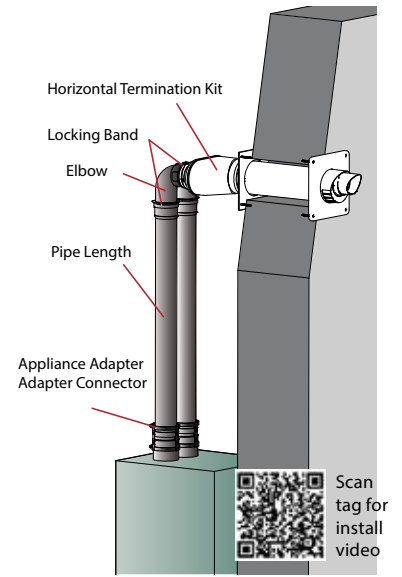

**Horizontal Twin Pipe Concentric**

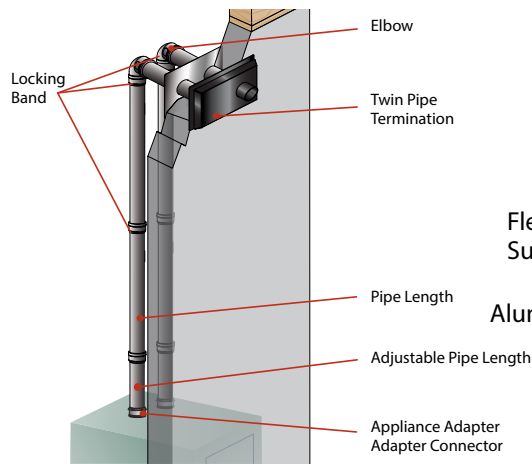

**Horizontal Below Grade**

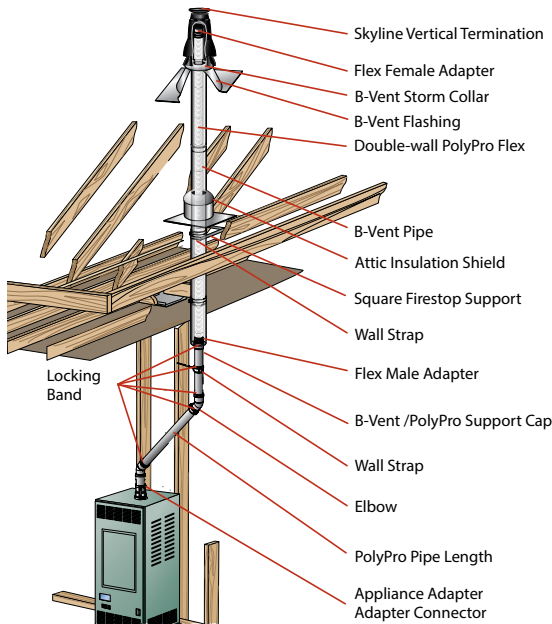

**Flex Through B vent as a Chase**

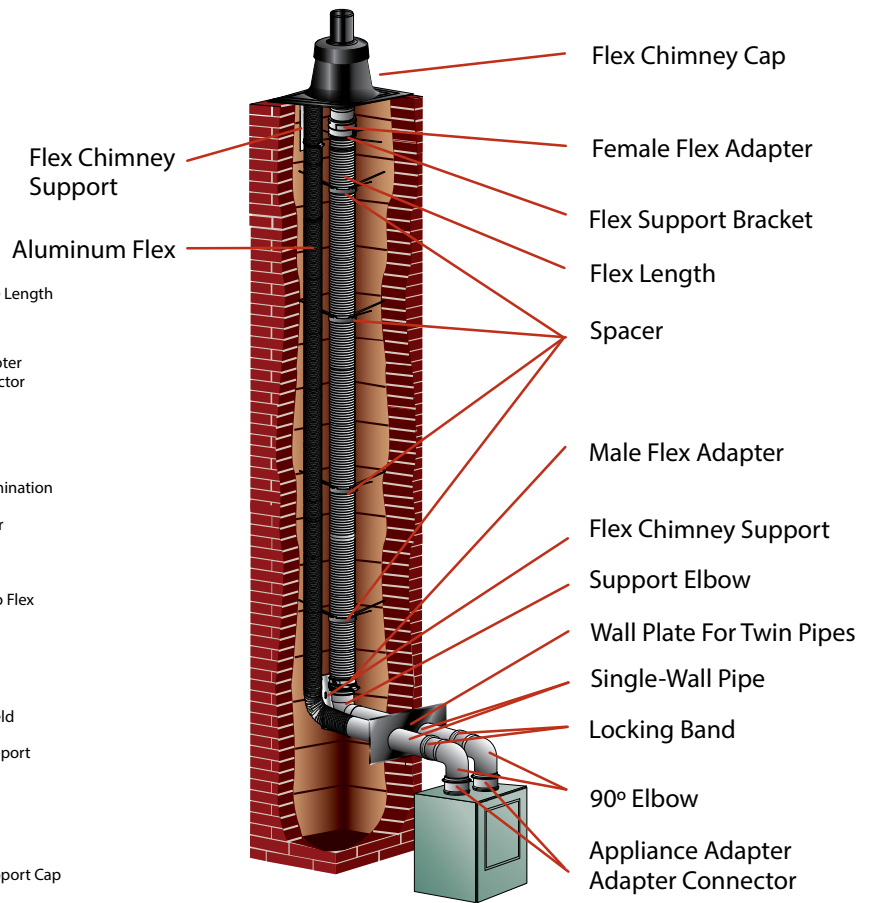

**Flex Through Chimney w/Air Intake**

See PolyPro Flex section for information on how to create your own air intake kit.



# PolyPro Venting System

## Single-Wall Pipe

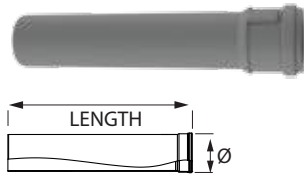

Use to vent condensing appliances. 2" | 60mm of overlap at the joint. Listed to ULC S636. Locking bands are required at all joint connections 2"-4" diameters.

SIZE	12"   305mm		36"   914mm		72"   1829mm	
	ORDER #	STOCK #	ORDER #	STOCK #	ORDER #	STOCK #
2"   60mm	2PPS-12	810004090	2PPS-36	810004092	2PPS-72	810004094
3"   80mm	3PPS-12	810004129	3PPS-36	810004131	3PPS-72	810004133
4"   100mm	4PPS-12	810004172	4PPS-36	810004174	4PPS-72	810004176
5"   130mm	5PPS-12	810004217	5PPS-36	810004218	5PPS-72	810004219
6"   150mm	6PPS-12	810004249	6PPS-36	810004251	6PPS-72	810004253
SIZE	40"   1016mm		75"   1905mm			
	ORDER #	STOCK #	ORDER #	STOCK #		
8"   200mm	8PPS-40	810004284	8PPS-75	810004285		

## Black UV Resistant Single-Wall Pipe

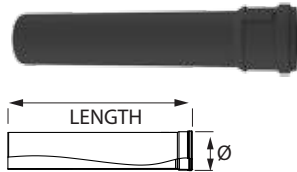

Use to vent condensing appliances. 2" | 60mm of overlap at the joint. Listed to ULC S636. Made of UV resistant polypropylene.

SIZE	12"   305mm		36"   914mm	
	ORDER #	STOCK #	ORDER #	STOCK #
2"   60mm	2PPS-12B	810004091	2PPS-36B	810004093
3"   80mm	3PPS-12B	810004130	3PPS-36B	810004132
4"   100mm	4PPS-12B	810004173	4PPS-36B	810004175
6"   150mm	6PPS-12B	810004250	6PPS-36B	810004252

## Adjustable Pipe

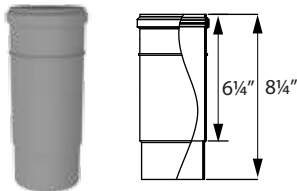

Use to add length to straight length of PolyPro pipe. Slips over standard single-wall pipe length. 4 1/2" | 114mm of adjustment. Adjustable pipe not available in 8" | 200mm diameter.

SIZE	ORDER #	STOCK #	SIZE	ORDER #	STOCK #
2"   60mm	2PPS-AVL	810004095	5"   130mm	5PPS-AVL	810004220
3"   80mm	3PPS-AVL	810004134	6"   150mm	6PPS-AVL	810004254
4"   100mm	4PPS-AVL	810004177			

## Test Port

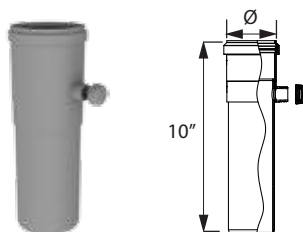

Use to test for proper appliance operation without penetrating or disconnecting the vent wall. Install immediately above the appliance.

SIZE	ORDER #	STOCK #	SIZE	ORDER #	STOCK #
2"   60mm	2PPS-TP	810004096	5"   130mm	5PPS-TP	810004221
3"   80mm	3PPS-TP	810004135	6"   150mm	6PPS-TP	810004255
4"   100mm	4PPS-TP	810004178	8"   200mm	8PPS-TP	810004286

### 45° Elbow

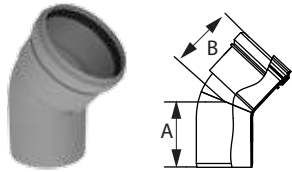

Offsets around obstructions as needed.

SIZE	ORDER #	STOCK #	A	B
2"   60mm	2PPS-E45	810004098	2 7/8"   72.5mm	2 11/16"   69mm
3"   80mm	3PPS-E45	810004137	2 7/8"   73mm	2 7/8"   73mm
4"   100mm	4PPS-E45	810004180	2 13/16"   78mm	2 13/16"   78mm
5"   130mm	5PPS-E45	810004222	3 3/4"   95mm	3 13/16"   98mm
6"   150mm	6PPS-E45	810004256	3 13/16"   98mm	3 15/16"   101mm
8"   200mm	8PPS-E45	810004287	4 7/16"   111mm	5 7/16"   131mm

### Black UV Resistant 45° Elbow

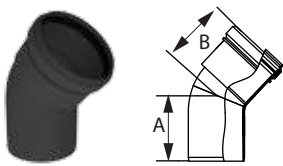

Offsets around obstructions as needed. Made of UV resistant polypropylene. May be used for terminations. Order Bird Guard Screen to protect opening.

SIZE	ORDER #	STOCK #	A	B
2"   60mm	2PPS-E45B	810004099	2 7/8"   73mm	2 11/16"   69mm
3"   80mm	3PPS-E45B	810004138	2 7/8"   73mm	2 7/8"   73mm
4"   100mm	4PPS-E45B	810004181	2 13/16"   78mm	2 1/2"   65mm

### 90° Elbow

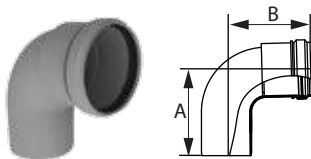

Offsets around obstructions as needed.

SIZE	ORDER #	STOCK #	A	B
2"   60mm	2PPS-E90	810004100	4"   100mm	4"   100mm
3"   80mm	3PPS-E90	810004139	4 5/16"   110mm	4 5/16"   110mm
4"   100mm	4PPS-E90	810004182	4 1/2"   115mm	4 1/2"   115mm
5"   130mm	5PPS-E90	810004223	6 3/4"   169mm	5 15/16"   152mm
6"   150mm	6PPS-E90	810004257	7 1/4"   183mm	6 1/2"   166mm
8"   200mm	8PPS-E90	810004288	8 15/16"   227mm	7 3/4"   195mm

### Black UV Resistant 90° Elbow

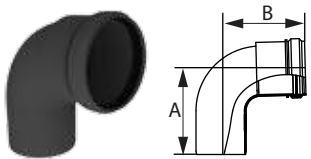

Offsets around obstructions as needed. Made of UV resistant polypropylene. May be used for terminations. Order Bird Guard Screen to protect opening.

SIZE	ORDER #	STOCK #	A	B
2"   60mm	2PPS-E90B	810004101	4"   100mm	4"   100mm
3"   80mm	3PPS-E90B	810004140	4 5/16"   110mm	4 5/16"   110mm
4"   100mm	4PPS-E90B	810004183	4 1/2"   115mm	4 1/2"   115mm
6"   150mm	6PPS-E90B	810004258	7 1/4"   183mm	6 1/2"   166mm

**Black UV Resistant Extended 90° Elbow**

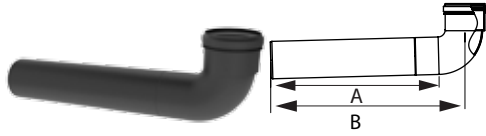

Made of UV resistant polypropylene. May be used for terminations. Order Bird Guard Screen to protect opening.

SIZE	ORDER #	STOCK #	A	B
2"   60mm	2PPS-E90EB	810004102	14"   358mm	16"   405mm
3"   80mm	3PPS-E90EB	810004141	14 1/4"   360mm	16 5/16"   415mm
4"   100mm	4PPS-E90EB	810004184	14 1/4"   360mm	16 1/2"   420mm

**Condensate Drain**

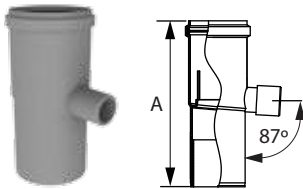

Use to properly manage corrosive condensates common with high efficiency gas appliances. Reference 8PPS-CD for 8" Tee Cap with integrated drain.

SIZE	ORDER #	STOCK #	A	SIZE	ORDER #	STOCK #	A
2"   50mm	2PPS-CD	810004104	7"   180mm	5"   130mm	5PPS-CD	810004227	7"   180mm
3"   80mm	3PPS-CD	810004143	7"   180mm	6"   150mm	6PPS-CD	810004260	7"   180mm
4"   100mm	4PPS-CD	810004186	7"   180mm				

**Tee Cap**



Use cap on Tees, Condensate Drain or on other components where a cap is needed.

SIZE	ORDER #	STOCK #	SIZE	ORDER #	STOCK #
2"   60mm	2PPS-C	810004103	5"   130mm	5PPS-C	810004226
3"   80mm	3PPS-C	810004142	6"   150mm	6PPS-C	810004261
4"   100mm	4PPS-C	810004185			

**Tee Cap with Condensate Drain**



Use cap on Tees, Condensate Drain or on other components where a cap is needed.

SIZE	ORDER #	STOCK #
8"   200mm	8PPS-CD	810004292

**Tee with Cap**

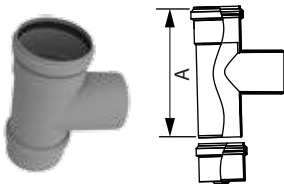

Use for a 90° offset or to combine connections. 8" diameter includes cap.

SIZE	ORDER #	STOCK #	A	SIZE	ORDER #	STOCK #	A
2"   60mm	2PPS-T	810004105	7"   180mm	5"   130mm	5PPS-T	810004228	11"   280mm
3"   80mm	3PPS-T	810004144	7 7/8"   200mm	6"   150mm	6PPS-T	810004262	11"   280mm
4"   100mm	4PPS-T	810004187	8 11/16"   220mm	8"   200mm	8PPS-T	810004293	13 13/16"   350mm

### Black UV Resistant Tee

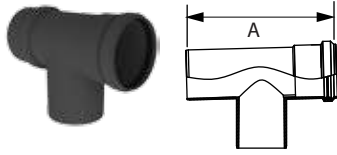

Use as a termination. Made of UV resistant polypropylene. Gasket not included. Order Bird Guard Screen to protect opening.

SIZE	ORDER #	STOCK #	A
2"   60mm	2PPS-TB	810004106	7"   180mm
3"   80mm	3PPS-TB	810004145	7 7/8"   200mm
4"   100mm	4PPS-TB	810004188	8 1/4"   220mm

### Black UV Resistant Termination Tee



Use as a termination. Manufactured with two female ends to accept Bird Screen on both ends. Use bird screen to protect openings. Made of UV resistant polypropylene. Bird Guard Screens included.

SIZE	ORDER #	STOCK #
6"   150mm	6PPS-TTB	810004455

### Black Wall Plate

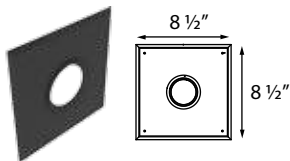

Use to trim wall penetration. Painted black metal with gasket.

SIZE	ORDER #	STOCK #	SIZE	ORDER #	STOCK #
2"   60mm	2PPS-WPB	810004112	4"   100mm	4PPS-WPB	810004195
3"   80mm	3PPS-WPB	810004152			

### Black Wall Plate for Twin Pipes

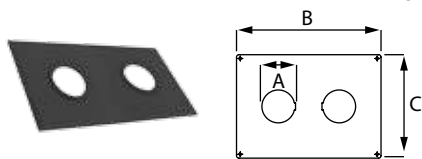

Use to trim wall penetration when using two pipes. Painted black metal with gasket.

SIZE	ORDER #	STOCK #	A	B	C
2"   60mm	2PPS-WPT	810004113	2"   60mm	11 7/8"   302mm	8 1/2"   216mm
3"   80mm	3PPS-WPT	810004153	3"   80mm	11 7/8"   302mm	8 1/2"   216mm
4"   100mm	4PPS-WPT	810004196	4"   100mm	12 7/8"   327mm	8 1/2"   216mm

### Tee with Drain Cap

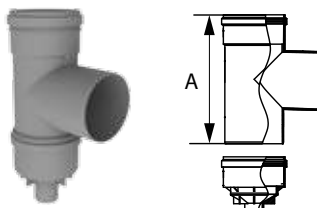

Use to manage condensates at the bottom of a vertical run.

SIZE	ORDER #	STOCK #	SIZE	ORDER #	STOCK #
2"   60mm	2PPS-TCD	810004107	5"   130mm	5PPS-TCD	810004229
3"   80mm	3PPS-TCD	810004146	6"   150mm	6PPS-TCD	810004263
4"   100mm	4PPS-TCD	810004189	8"   200mm	8PPS-TCD	810004294

## Reducer



Use to transition the vent system to a smaller diameter.

SIZE	ORDER #	STOCK #	A
3" - 2"   80 - 60mm	3PPS-R2	810004148	5"   130mm
4" - 3"   100 - 80mm	4PPS-R3	810004191	5"   130mm
5" - 4"   130 - 100mm	5PPS-R4	810004231	7 5/8"   193mm
6" - 5"   150 - 130mm	6PPS-R5	810004265	7 3/4"   197mm
8" - 6"   200 - 150mm	8PPS-R6	810004295	5 15/16"   150mm

## Increaser



Use to transition the vent system to a larger diameter. Install in vertical orientation.

SIZE	ORDER #	STOCK #	A
2" - 3"   60 - 80mm	2PPS-X3	810004108	4 5/16"   110mm
3" - 4"   80 - 100mm	3PPS-X4	810004147	4 5/16"   110mm
4" - 5"   100 - 130mm	4PPS-X5	810004190	4 5/16"   110mm
5" - 6"   130 - 150mm	5PPS-X6	810004230	4 5/16"   110mm
6" - 8"   150 - 200mm	6PPS-X8	810004264	5 3/4"   145mm

## Appliance Adapter for PVC Pipe



Use to connect PolyPro vent system to an appliance outlet. Has a double female adapter. One end accepts PVC male pipe and the other accepts PolyPro male pipe. No adapter connector and/or locking band required.

SIZE	ORDER #	STOCK #
3"   80mm	3PPS-AD-M	810007169
4"   100mm	4PPS-AD-M	810007170

## Appliance Adapter for PVC Coupler



Use to adapt rigid PolyPro pipe length to PVC/CPVC coupler or other plastic appliance outlet. Must be used with Adapter Connector for flue gas.

SIZE	ORDER #	STOCK #	SIZE	ORDER #	STOCK #
2"   60mm	2PPS-AD	810004097	4"   100mm	4PPS-AD	810004179
3"   80mm	3PPS-AD	810004136			

### Female Appliance Adapter



Use to connect PolyPro to a nominal sized pipe with a smooth male end outlet. No adapter connector and/or locking band required. Hose clamps on both ends.

SIZE	ORDER #	STOCK #	A	B	C
6"   150mm	F5AAU6-6PP	810004283	5 15/16"   151mm	6"   150mm	5"   130mm
8"   200mm	F5AAU3-3PP	810004312	7 15/16"   199mm	8"   200mm	5"   130mm

### Male PVC Appliance Adapter

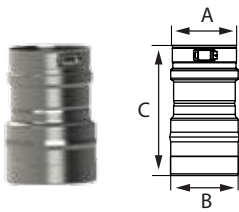

Use to connect PolyPro vent system to a standard stainless steel appliance outlet equipped with an integrated hose clamp and gasket. Must be used with Adapter Connector for flue gas, unless a clamp is supplied on the appliance outlet. Same O.D. as PVC.

SIZE	ORDER #	STOCK #	A	B	C
3"   80mm	3PPS-03PVCM-3PPF	810004167	3 3/16"   81mm	3 1/2"   89mm	6 13/16"   173mm
4"   100mm	4PPS-04PVCM-4PPF	810004207	4"   102mm	4 1/2"   114mm	6 13/16"   173mm
6"   150mm	6PPS-06PVCM-6PPF	810004281	5 3/16"   132mm	5 9/16"   141mm	6 13/16"   173mm
8"   200mm	8PPS-08PVCM-8PPF	810004310	6"   152mm	6 5/8"   168mm	6 15/16"   176mm

### Female PVC Appliance Adapter

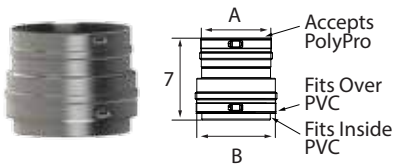

Use to connect PolyPro to a male PVC Pipe appliance outlet. No adapter connector and/or locking band required.

SIZE	ORDER #	STOCK #	A	B
5"   130mm	5PPS-05PVCF-5PPF	810004244	5"   130mm	5 11/16"   144mm
6"   150mm	6PPS-06PVCF-6PPF	810004280	5 15/16"   151mm	6 11/16"   170mm
8"   200mm	8PPS-08PVCF-8PPF	810004309	7 15/16"   132mm	7 7/8"   200mm

### FasNSeal Adapter

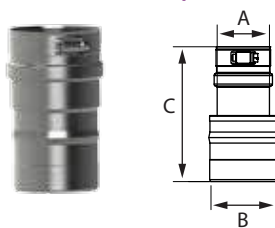

Use to transition from FasNSeal vent system to PolyPro vent system. Can be used as an appliance adapter or inline. No locking band required.

SIZE	ORDER #	STOCK #	A	B	C
3"   80mm	FSA-03M-2PPF	810004170	2 3/8"   60mm	3"   76mm	6 1/8"   156mm
3"   80mm	FSA-03M-3PPF	810004169	3 1/8"   79mm	3"   76mm	5 15/16"   151mm
4"   100mm	FSA-04M-4PPF	810004209	4"   100mm	4"   100mm	5 15/16"   151mm
5"   130mm	FSA-05M-5PPF	810004247	5 3/16"   132mm	5"   130mm	5 15/16"   151mm
6"   150mm	FSA-06M-6PPF	810007030	5 15/16"   151mm	6"   150mm	6"   150mm
7"   178mm	FSA-07M-6PPF	810004463	6 1/8"   156mm	6 5/16"   160mm	7"   178mm
8"   200mm	FSA-08M-8PPF	810007031	8"   200mm	8"   200mm	6"   150mm

### PolyPro to FasNSeal Adapter

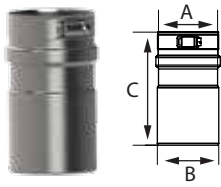

Use to transition from PolyPro vent system to FasNSeal vent system or to connect a metric appliance to FasNSeal. Can be used as an appliance adapter or inline. Locking band required for 3" - 4" diameters, recommended for 5" - 8" diameters.

SIZE	ORDER #	STOCK #	A	B	C
3"   80mm	3PPS-ADM-03FNSF	810004168	3"   80mm	3 1/8"   79mm	3 13/16"   97mm
4"   100mm	4PPS-ADM-04FNSF	810004208	4"   100mm	3 1/2"   99mm	5 15/16"   151mm
5"   130mm	5PPS-ADM-05FNSF	810004246	5"   130mm	5 1/8"   131mm	5 15/16"   151mm
6"   150mm	6PPS-ADM-06FNSF	810004282	6"   150mm	5 15/16"   151mm	7"   178mm
8"   200mm	8PPS-ADM-08FNSF	810004311	8"   200mm	7 7/8"   199mm	7"   178mm

### Adapter Connector



Use to secure PolyPro pipe to PVC/CPVC coupler or appliance outlet. Universal size for 2-4 inch and 5-8 inch systems. M&G DuraVent requires its use with flue gas applications and recommends it with air intake applications.

SIZE	ORDER #	STOCK #	SIZE	ORDER #	STOCK #
2" - 4"	PPS-PAC	810004128	5" - 8"	PPS-PACL	810004243

### Wall Strap - metal

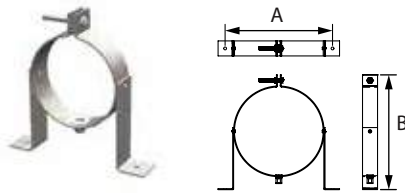

Use to support offsets and pipe used in vertical rise or horizontal runs as per installation instructions. Wall Strap legs can be rotated up to 360° for versatility. Accepts standard 1/4" all-thread. Available in galvanized or stainless steel metals. Note: Vent pipe must be supported at least every 10 feet (3m) vertically. Horizontal or sloped sections of vent pipe require a wall strap on each pipe section.

SIZE	GALVANIZED		A	B
	ORDER #	STOCK #		
2"   60mm	2PPS-WSM	810004110	3 5/8"   92mm	4 7/8"   124mm
3"   80mm	3PPS-WSM	810004150	4 3/8"   112mm	5 1/4"   133mm
4"   100mm	4PPS-WSM	810004193	5 1/8"   130mm	5 5/8"   143mm
5"   130mm	5PPS-WSM	810004232	6 3/8"   162mm	6 3/4"   171mm
6"   150mm	6PPS-WSM	810004266	7 1/8"   181mm	7 5/8"   194mm
8"   200mm	8PPS-WSM	810004296	9 1/8"   232mm	9 5/8"   245mm
SIZE	STAINLESS STEEL		A	B
	ORDER #	STOCK #		
2"   60mm	2PPS-WSM-SS	810004111	3 5/8"   92mm	4 7/8"   124mm
3"   80mm	3PPS-WSM-SS	810004151	4 3/8"   112mm	5 1/4"   133mm
4"   100mm	4PPS-WSM-SS	810004194	5 1/8"   130mm	5 5/8"   143mm
5"   130mm	5PPS-WSM-SS	810004233	6 3/8"   162mm	6 3/4"   171mm
6"   150mm	6PPS-WSM-SS	810004267	7 1/8"   181mm	7 5/8"   194mm
8"   200mm	8PPS-WSM-SS	810004297	9 1/8"   232mm	9 5/8"   245mm

### Locking Band



Use to secure two sections of pipe together. Required to comply with ULC S636 listed installations for 2" to 4" diameters. Locking Bands are recommended for 5" diameter.

SIZE	ORDER #	STOCK #	SIZE	ORDER #	STOCK #
2"   60mm	2PPS-LB	810004127	4"   100mm	4PPS-LB	810004206
3"   80mm	3PPS-LB	810004166	5"   130mm	5PPS-LB	810004241

### Locking Band Clamp

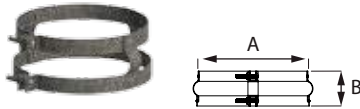

Use to secure two sections of pipe together. Locking Bands are recommended for 5"-8" diameters. Use to secure two sections of PolyPro pipe together. Typically used in vertical installations.

SIZE	ORDER #	STOCK #	A	B
2"   60mm	2PPS-LBC	810007146	2 3/8"   60mm	2 1/2"   64mm
3"   80mm	3PPS-LBC	810007147	3 1/8"   80mm	2 1/2"   64mm
4"   100mm	4PPS-LBC	810007148	4"   100mm	2 1/2"   64mm
5"   130mm	5PPS-LBC	810004242	5 1/8"   130mm	2 1/2"   64mm
6"   150mm	6PPS-LBC	810004278	6 1/8"   156mm	2 1/2"   64mm
8"   200mm	8PPS-LBC	810004306	8 1/8"   207mm	2 1/2"   64mm

### Firestop Spacer

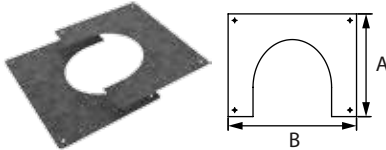

Use when penetrating floor levels. Two piece design for easier installation.

SIZE	SINGLE-WALL PIPE		A	B
	ORDER #	STOCK #		
2"   60mm	2PPS-FSS	810004115	4"   100mm	7"   178mm
3"   80mm	3PPS-FSS	810004155	4"   100mm	7"   178mm
4"   100mm	4PPS-FSS	810004198	4"   100mm	7"   178mm
5"   130mm	5PPS-FSS	810004234	8 1/8"   206mm	10"   254mm
6"   150mm	6PPS-FSS	810004269	7 3/4"   197mm	9 3/4"   248mm
8"   200mm	8PPS-FSS	810004298	10 1/2"   267mm	12 3/4"   324mm
SIZE	CONCENTRIC PIPE		A	B
	ORDER #	STOCK #		
2"   60mm	2PPS-FS	810004114	7"   178mm	8 3/4"   223mm
3"   80mm	3PPS-FS	810004154	7 7/8"   200mm	9 7/8"   251mm
4"   100mm	4PPS-FS	810004197	7 7/8"   200mm	9 7/8"   251mm

### Flat Roof Flashing

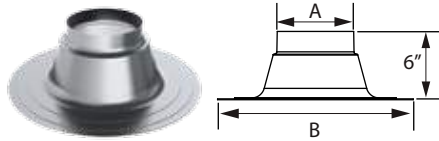

Use to weather-proof the penetration of vent pipe through the roof. For concentric pipe.

SIZE	ORDER #	STOCK #	A	B
2"   60mm	2PPS-FF	810004116	4 5/8"   120mm	13 3/4"   350mm
3"   80mm	3PPS-FF	810004156	5 1/2"   140mm	15 5/16"   390mm
4"   100mm	4PPS-FF	810004199	6 1/4"   170mm	17"   430mm
5"   130mm	5PPS-FF	810007171	5 1/2"   140mm	--
6"   150mm	6PPS-FF	810004268	6 1/4"   160mm	--
8"   200mm	8PPS-FF	810004302	8 1/4"   210mm	--

### Adjustable Roof Flashing: 1/12 - 5/12 pitch

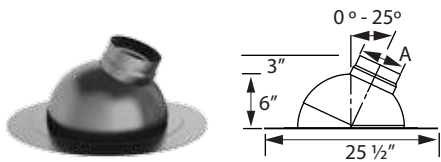

Use to weather proof penetration of vent through the roof. For concentric pipe. Made of aluminum. Adjusts from 0 - 25° (0/12 to 5/12).

SIZE	ORDER #	STOCK #	A
2" x 4"   60 - 100mm	2PPS-F5	810004117	4"   100mm
3" x 5"   80 - 130mm	3PPS-F5	810004157	5"   130mm
4" x 6"   100 - 150mm	4PPS-F5	810004200	6"   150mm

### Adjustable Roof Flashing: 5/12 - 12/12 pitch

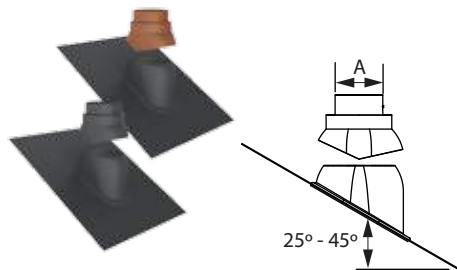

Use to weather proof penetration of vent through the roof. For concentric pipe. Made of polypropylene. Adjusts from 25° to 45° (5/12 to 12/12). Black or terra-cotta. UV resistant.

SIZE	BLACK		A
	ORDER #	STOCK #	
2" x 4"   60 - 100mm	2PPS-F12	810004118	4"   100mm
3" x 5"   80 - 130mm	3PPS-F12	810004158	5"   130mm
4" x 6"   100 - 150mm	4PPS-F12	810004201	6"   150mm
SIZE	TERRA-COTTA		A
	ORDER #	STOCK #	
2" x 4"   60 - 100mm	2PPS-F12-TC	810004119	4"   100mm
3" x 5"   80 - 130mm	3PPS-F12-TC	810004159	5"   130mm
4" x 6"   100 - 150mm	4PPS-F12-TC	810004202	6"   150mm

### Twin Pipe Termination

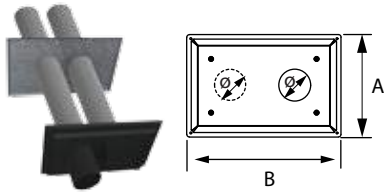

Use to terminate horizontally with two single-wall PolyPro pipes for intake and exhaust. Simple design ensures adequate separation of intake air from exhaust. Termination is painted black. Includes black UV resistant polypropylene exhaust nozzle equipped with Bird Screen, interior wall plate, and two 14" pipe lengths.

SIZE	ORDER #	STOCK #	A	B
2"   60mm	2PPS-HTP	810004120	8 1/2"   216mm	11 7/8"   302mm
3"   80mm	3PPS-HTP	810004160	8 1/2"   216mm	11 7/8"   302mm
4"   100mm	4PPS-HTP	810004436	8 1/2"   216mm	12 1/4"   311mm

### Single Horizontal Termination

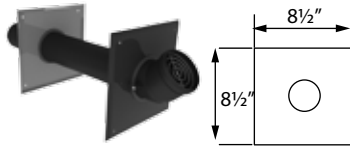

Use to terminate horizontally with one single-wall PolyPro pipe. Termination and wall plate can be rotated to suit application. Elbow is UV resistant black with bird screen. Also includes interior wall plate, and 14" length of pipe.

SIZE	ORDER #	STOCK #
2"   60mm	2PPS-HST	810004121
3"   80mm	3PPS-HST	810004161

### Lochinvar Horizontal Termination Kit



Use to adapt PolyPro to the IpeX 636 low profile termination. Kit includes 14" pipe welded to an adapter and metal backing plate. Check with appliance manufacturer for approval. (Outer IPEX termination cap not included. Supplied by others.)

SIZE	ORDER #	STOCK #	A	B
2"   60mm	2PPS-HLK	810004123	14 3/16"   360mm	8 5/8"   220mm
3"   80mm	3PPS-HLK	810004163	14 3/16"   360mm	8 5/8"   220mm
4"   100mm	4PPS-HLK	810004203	14 3/16"   360mm	8 5/8"   220mm

### Vertical Termination Cap Kit - Concentric

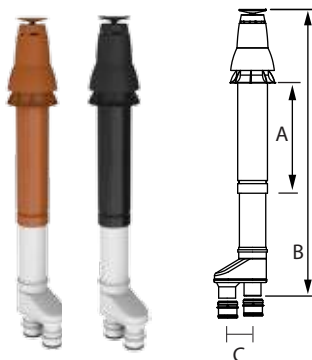

Use for concentric vertical terminations. Includes 2 appliance adapters and co-linear adapter. Black or terra-cotta cap. UV resistant.

SIZE	BLACK		A	B	C
	ORDER #	STOCK #			
2" x 4"   60 x 100mm	2PPS-VK	810004084	18"   460mm	50 1/4"   1280mm	4 3/4"   121mm
3" x 5"   80 x 125mm	3PPS-VK	810004086	23"   580mm	53 1/4"   1354mm	4 3/4"   121mm
4" x 6"   100 x 150mm	4PPS-VK	810004088	23"   580mm	68 1/4"   1735mm	5 1/2"   140mm
SIZE	TERRA-COTTA		A	B	C
	ORDER #	STOCK #			
2" x 4"   60 x 100mm	2PPS-VK-TC	810004085	18"   460mm	50 1/4"   1280mm	4 3/4"   121mm
3" x 5"   80 x 125mm	3PPS-VK-TC	810004087	23"   580mm	53 1/4"   1354mm	4 3/4"   121mm
4" x 6"   100 x 150mm	4PPS-VK-TC	810004089	23"   580mm	68 1/4"   1735mm	5 1/2"   140mm

### Horizontal Termination Kit - Concentric

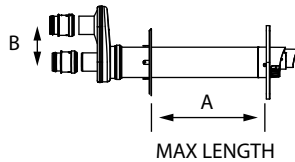

Use for concentric horizontal terminations. Includes 2 appliance adapters, white wall plate, white firestop, and co-linear adapter. White Termination with Bird Guard Screen. UV resistant. Inner plate is 8 5/8" (220mm) square, outer plate is 9 7/16" (240mm) square for all flue sizes.

SIZE	ORDER #	STOCK #	A	B
2" - 4"   60 - 100mm	2PPS-HK	810004081	13 3/4"   350mm	4 3/4"   121mm
3" x 5"   80 - 125mm	3PPS-HK	810004082	13"   330mm	4 3/4"   121mm
4" x 6"   100 - 150mm	4PPS-HK	810004083	13 3/4"   350mm	5 1/2"   140mm

### Bird Guard Screen



Use to protect venting system from birds and rodents. Position inside pipe in place of gasket. Stainless steel. Pack of 6.

SIZE	ORDER #	STOCK #	SIZE	ORDER #	STOCK #
2"   60mm	2PPS-BG	810004341	4"   100mm	4PPS-BG	810004341
3"   80mm	3PPS-BG	810004355	6"   150mm	6PPS-BG	810004276

### EPDM Replacement Gasket



Use as a replacement gasket for rigid PolyPro products. Pack of 12.

SIZE	ORDER #	STOCK #	SIZE	ORDER #	STOCK #
2"   60mm	2PPS-GA	810004124	5"   130mm	5PPS-GA	810004237
3"   80mm	3PPS-GA	810004164	6"   150mm	6PPS-GA	810004272
4"   100mm	4PPS-GA	810004204	8"   200mm	8PPS-GA	810004303

### Viton Replacement Gasket



Use as a gasket for oil fuel appliances.

SIZE	ORDER #	STOCK #	SIZE	ORDER #	STOCK #
2"   60mm	2PPS-GAV	810004126	5"   130mm	5PPS-GAV	810004238
3"   80mm	3PPS-GAV	810004165	6"   150mm	6PPS-GAV	810004273
4"   100mm	4PPS-GAV	810004205	8"   200mm	8PPS-GAV	810004304

# PolyPro Commercial Venting Components

## Vertical Termination for Commercial Systems

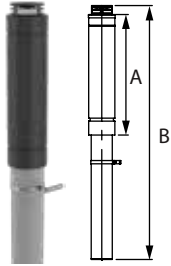

Exhaust termination for vertical through-the-roof applications. PolyPro pipe is protected by a sturdy outer metal pipe and integrated cap. Painted with a durable, powder coated black finish. Includes support hardware.

To complete vertical termination for commercial systems, installation requires (1) variable pitch roof flashing, (1) support clamp, and (1) storm collar.

SIZE	ORDER #	STOCK #	A	B	O.D.
5"   130mm	5PPS-VTM	810004239	29"   745mm	62"   1575mm	6 3/8"   162mm
6"   150mm	6PPS-VTM	810004274	29"   741mm	62"   1575mm	7 1/4"   184mm
8"   200mm	8PPS-VTM	810004307	32"   800mm	63"   1600mm	9 1/8"   232mm

## Variable Pitch Roof Flashing

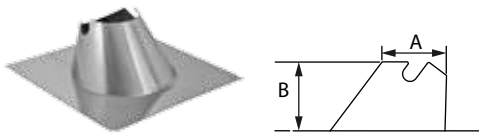

Use to weather-proof the penetration of vent pipe through the roof. For use with VTM. For pitches of 0/12 - 9/12. Made of stainless steel.

SIZE	ORDER #	STOCK #	A	B
5"   130mm	FSVPF5	810003241	7"	7"
6"   150mm	FSVPF6	810003295	8"	7"
8"   200mm	FSVPF8	810003383	9"	7"

## Support Clamp



Use to support vertical and horizontal runs using standard threaded rod. Recommended every 10' on vertical runs and every 6' in horizontals. For use with PolyPro Commercial Vent Lengths. Use additional Support Clamps as needed.

SIZE	ORDER #	STOCK #	A
5"   130mm	FSCL5	810003235	1 1/2"
6"   150mm	FSCL6	810003288	1 1/2"
8"   200mm	FSCL8	810003375	1 1/2"

## Storm Collar



Use to create a weather tight seal between the pipe and flashing. For use with VTM.

SIZE	ORDER #	STOCK #
5"   130mm	FSCPP5	810007172
6"   150mm	FSCPP6	810007173
8"   200mm	FSCPP8	810007174

### Horizontal Termination for Commercial Systems

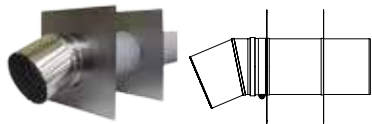

Use to terminate through-the-wall applications. 23 degree Elbow termination made with stainless steel and will fit over PolyPro pipe. Includes bird guard. The kit does not contain a PolyPro adapter. No additional locking band is required. For assembly, follow enclosed instructions.

SIZE	ORDER #	STOCK #
5"   130mm	5PPS-HST	810004240
6"   150mm	6PPS-HST	810004275
8"   200mm	8PPS-HST	810004308

## PolyPro Flex Venting System

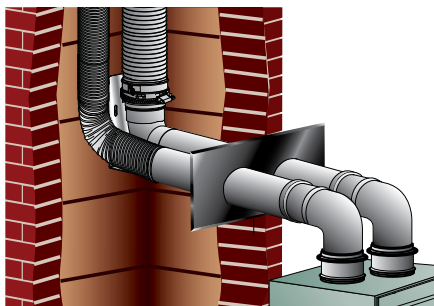

### Need An Air Intake Solution? Create Your Own Kit

Order DuraFlex AL length, Hanger Bracket, Coupler and Wall Plate for Twin Pipe. (2" Air intake will require a 2"-3" Increaser: 2PPS-X3)

- (1) DuraFlex AL Length: DFA-25, DFA-35, or DFA-50
- (1) Hanger Bracket: DFA-FCB
- (1) Coupler: DFA-FCP
- (1) Wall Plate for Twin Pipe: PPS-WPT

### Flex Chimney Lining Kit



Use for a vertical flex lining system. Includes black, UV resistant chimney cap, rigid flue vent, flex support bracket, 4 spacers in 3" & 4" kits, male and female flex adapters with gaskets, extended support elbow, wall plate and appliance adapter. Flex sold separately.

SIZE	ORDER #	STOCK #
2"   60mm	2PPS-FK	810004314
3"   80mm	3PPS-FK	810004315
4"   100mm	4PPS-FK	810004316
5"   130mm	5PPS-FK	810004317

### Chimney Cap



Use to vertically terminate a flex system. Black, UV resistant chimney cap with rigid steel flue vent.

SIZE	ORDER #	STOCK #
2"   60mm	2PPS-FCT	810004328
3"   80mm	3PPS-FCT	810004343
4"   100mm	4PPS-FCT	810004357
5"   130mm	5PPS-FCT	810004369

### Vertical Flex Termination Cap

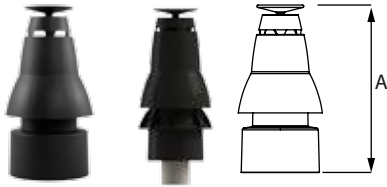

Use to vertically terminate a flex system when using the B-vent retrofit adapters. Includes male and female flex adapters and gaskets. Black, UV resistant. Match the termination size with the diameter of flex you are using.

SIZE	ORDER #	STOCK #	A
2"   60mm	2PPS-VFT	810004122	13 3/4"   349mm
3"   80mm	3PPS-VFT	810004162	17"   432mm

### B-vent Retrofit Adapters

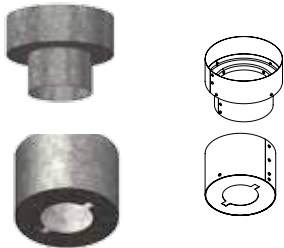

Use to retrofit any B-vent pipe as a chase for PolyPro flex when an old appliance has been replaced with a new condensing 90+ appliance. Includes adapter to cap and flex/B-vent support. For venting a single appliance (not for common-venting).

SIZE	ORDER #	STOCK #
2"   60mm in a 4"   100mm chase	2PPS-BV4	810004333
2"   60mm in a 5"   130mm chase	2PPS-BV5	810004334
3"   80mm in a 5"   130mm chase	3PPS-BV5	810004348
2"   60mm in a 6"   150mm chase	2PPS-BV6	810006999
3"   80mm in a 6"   150mm chase	3PPS-BV6	810005874

### Support Elbow



Use the support elbow to stabilize a vertical termination. Elbow has integrated support base that is compatible with bracket or support shown on the following page.

SIZE	ORDER #	STOCK #	SIZE	ORDER #	STOCK #
5"   130mm	5PPS-SE90	810004374	8"   100mm	8PPS-SE90	810004289
6"   60mm	6PPS-SE90	810004259			

### Support Elbow Extended

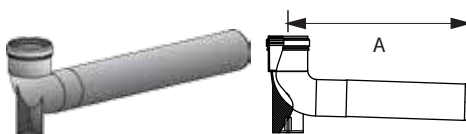

Use the extended support elbow to stabilize the vertical termination. Extended horizontal length can be trimmed to size. Elbow has integrated support base that is compatible with bracket or support shown on the following page.

SIZE	ORDER #	STOCK #	A
2"   60mm	2PPS-SE90X	810004337	21 1/16"   551mm
3"   80mm	3PPS-SE90X	810004351	22 1/4"   565mm
4"   100mm	4PPS-SE90X	810004363	22 7/16"   570mm
5"   130mm	5PPS-SE90X	810004374	24 7/16"   620mm

### Flex or Rigid Support Bracket



Use to secure the Support Elbow or the Extended Support Elbow inside a masonry chimney or chase. Heavy Duty.

SIZE	ORDER #	STOCK#
2" - 8"   60mm - 200mm	PPS-SUP	810004225

### Flex Chimney Support

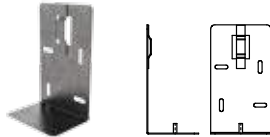

Use to support the Support Elbow inside a masonry chimney or chase. Comes with mounting hardware and pipe support clamp.

SIZE	ORDER #	STOCK #	SIZE	ORDER #	STOCK #
2"   60mm	2PPS-SUP	810004338	4"   100mm	4PPS-SUP	810004364
3"   80mm	3PPS-SUP	810004352	5"   130mm	5PPS-SUP	810004375

### Flex Support Bracket

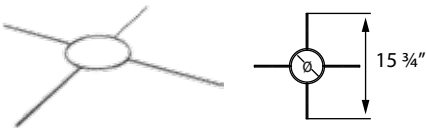

Use to support PolyPro Flex from top of masonry chimney or chase.

SIZE	ORDER #	STOCK #	SIZE	ORDER #	STOCK #
2"   60mm	2PPS-FSB	810004335	4"   100mm	4PPS-FSB	810004361
3"   80mm	3PPS-FSB	810004349	5"   130mm	5PPS-FSB	810004373

### Spacer



Use to center PolyPro flex. Universal for all diameters. Simple installation and ratchet adjustment. For 3" & 4" diameters, use 3PPS-S.

SIZE	ORDER #	STOCK #	SIZE	ORDER #	STOCK #
2"   60mm	2PPS-S	810004336	3"   80mm	3PPS-S	810004350

### Flex Length



Use to line masonry chimneys that vent condensing appliances. Double-wall construction. Can be cut to precise length in the field. Available in 25, 35 or 50 foot lengths. 5" diameter flex comes in rolls of 98 feet only.

SIZE	25 FEET		35 FEET	
	ORDER #	STOCK #	ORDER #	STOCK #
2"   60mm	2PPS-FLEX25	810004318	2PPS-FLEX35	810004319
3"   80mm	3PPS-FLEX25	810004321	3PPS-FLEX35	810004322
4"   100mm	4PPS-FLEX25	810004324	4PPS-FLEX35	810004325
SIZE	50 FEET		82 FEET	
	ORDER #	STOCK #	ORDER #	STOCK #
2"   60mm	2PPS-FLEX50	810004320	-	-
3"   80mm	3PPS-FLEX50	810004323	-	-
4"   100mm	-	-	4PPS-FLEX	810004326
SIZE	98 FEET			
	ORDER #	STOCK #		
5"   130mm	5PPS-FLEX	810004327		

### Flex Adapter Kit



Use with PolyPro flex lining system. Includes one male and one female adapter. These allow you to switch from rigid pipe to flex at the base of the system and back to rigid at the top. Flex gaskets (2) included.

SIZE	ORDER #	STOCK #	SIZE	ORDER #	STOCK #
3"   80mm	3PPS-FAS	810007032	5"   130mm	5PPS-FAS	810007033
4"   100mm	4PPS-FAS	810005987			

### Flex Male Adapter



Use to connect PolyPro rigid pipe to PolyPro flex at the base of the system. Flex gasket included.

SIZE	ORDER #	STOCK #	SIZE	ORDER #	STOCK #
2"   60mm	2PPS-FAM	810004329	4"   100mm	4PPS-FAM	810004358
3"   80mm	3PPS-FAM	810004344	5"   130mm	5PPS-FAM	810004370

### Flex Female Adapter



Use to terminate PolyPro flex lining system back to a rigid system. Flex gasket included.

SIZE	ORDER #	STOCK #	SIZE	ORDER #	STOCK #
2"   60mm	2PPS-FAF	810004330	4"   100mm	4PPS-FAF	810004359
3"   80mm	3PPS-FAF	810004345	5"   130mm	5PPS-FAF	810004371

### Flex Coupler Adapter



Use to tightly connect one length of PolyPro flex to another. Flex gasket included.

SIZE	ORDER #	STOCK #	SIZE	ORDER #	STOCK #
2"   60mm	2PPS-FAC	810004331	4"   100mm	4PPS-FAC	810004360
3"   80mm	3PPS-FAC	810004346	5"   130mm	5PPS-FAC	810004372

### Wall Plate

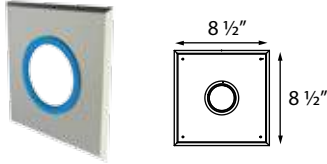

Use to trim wall penetration. Comes with silicone seal for tight seal. Aluminum construction. White finish. Can be painted to suit.

SIZE	ORDER #	STOCK #	SIZE	ORDER #	STOCK #
2"   60mm	2PPS-WP	810004339	4"   100mm	4PPS-WP	810004365
3"   80mm	3PPS-WP	810004353	5"   130mm	5PPS-WP	810004376

### Viton Replacement Gasket Flex



Use as a replacement gasket for PolyPro flex products.

SIZE	ORDER #	STOCK #	SIZE	ORDER #	STOCK #
2"   60mm	2PPS-GAF	810004340	4"   100mm	4PPS-GAF	810004366
3"   80mm	3PPS-GAF	810004354	5"   130mm	5PPS-GAF	810004377

### Flex Puller



Use with the provided rope to guide PolyPro flex lengths down masonry chimney. 2" version snaps onto flex, 3"-5" version twist-locks onto the male flex adapter.

SIZE	ORDER #	STOCK #	SIZE	ORDER #	STOCK #
2"   60mm	2PPS-FP	810004342	4"   100mm	4PPS-FP	810004368
3"   80mm	3PPS-FP	810004356	5"   130mm	5PPS-FP	810004378



### OEM Appliance Approvals of PolyPro

For a current list and more details, go to our website at [www.duravent.com](http://www.duravent.com) to the PolyPro page and look for the OEM bulletin, or scan code with your smart phone.

1. **PRICES:** All prices and designs are subject to change without notice.
2. **CREDIT:** All sales are subject to credit approval.
3. **SALES TAX:** All sales are taxable unless buyer provides valid resale documentation prior to shipment. Buyer is responsible for all sales and use taxes.
4. **BROKEN CARTON CHARGES:** Broken carton orders are subject to broken carton charges.
5. **PALLET CHARGES:** All palletized, stretch-wrapped orders are an additional \$5 per pallet.
6. **UPS:** All UPS orders are subject to \$10 handling charge.
7. **TERMS:** Unless otherwise specified, our payment terms are: net 30, F.O.B. shipping point.
8. **LATE CHARGES:** Delinquent accounts are subject to 1 ½% per month finance charge.
9. **MULTIPLE SHIPMENTS:** Orders may be fulfilled in separate shipments. Each shipment will be accompanied by a separate invoice and each invoice carries its own terms of payment.
10. **ALL SALES ARE FINAL:** All sales are final and product cannot be returned for credit.
11. **DELAYS:** DuraVent is not responsible for delays caused by our freight providers.
12. **REFUSAL OF DELIVERY:** Refused shipments, without cause, will result in additional charges, including freight, restocking and recartoning.
13. **SHORTAGES:** All claims for shortages and damages must be made within 48 hours.
14. **DAMAGE:** DuraVent is not responsible for freight damage. All claims for damage must be made on a timely basis directly to the freight provider. Any evidence of damage to the carton is cause for immediate inspection of the goods. Damaged goods must be retained by the customer until credit is approved. All claims for damages must be accompanied by proof (e.g. digital photo) and is subject to approval by DuraVent.
15. **DEFECTS:** All claims for manufacturing defects must be accompanied by proof (e.g. digital photo) and is subject to approval by DuraVent.
16. **INDEMNITY:** DuraVent does not permit modifications to products or changes to installation instructions. Customers modifying products or installation procedures shall, regardless of specific instructions to the user, indemnify, defend, and hold harmless DuraVent for any and all claimed losses or damages occasioned in whole or in part by special order or modified products and procedures.
17. **RESALE OVER THE INTERNET:** Resale of product over the internet is subject to the terms of our "Internet Sales Policy" and warranty. A copy of this policy can be obtained from Customer Service at 1-800-835-4429.

M&G DuraVent, Inc. ("DuraVent") provides this warranty for PolyPro® for ten years. Subject to the limitations set forth below, DuraVent warrants that its products will be free from defects in material or manufacturing, if properly installed, maintained and used. DuraVent products are fully warranted if installed only by a professional installer. This Warranty is transferable from the original homeowner to the buyer of the home within the warranted ten years. This warranty does not cover normal wear and tear, smoke damage or damage caused by chimney fires, acts of God, or any product that was: (1) purchased other than from an authorized DuraVent dealer, retailer or distributor; (2) modified or altered; (3) improperly serviced, inspected or cleaned; or (4) subject to negligence or any use not in accordance with the installation instructions included with the product as determined by DuraVent.

Installation instructions are available online at [www.duravent.com](http://www.duravent.com) under Support/Literature and through our Customer Service Department 800-835-4429 or [customerservice@duravent.com](mailto:customerservice@duravent.com).

DuraVent provides the following warranties for PolyPro: One Hundred Percent (100%) MSRP 10 years from the date of purchase.

All warranty obligations of DuraVent shall be limited to repair or replacement of the defective product pursuant to the terms and conditions applicable to each product line. These remedies shall constitute DuraVent's sole obligation and sole remedy under this warranty. This warranty provides no cash surrender value. The terms and conditions of this warranty may not be modified, altered or waived by any action, inaction or representation, whether oral or in writing, except upon the express, written authority of an executive officer of DuraVent.

This product is intended for venting only category II & IV appliances burning Natural Gas, Propane and Oil. All other fuels are not covered under this warranty.

LIMITATIONS ON POLYPRO INTERNET SALES: Notwithstanding any other terms or conditions of this PolyPro Warranty, DuraVent provides no warranty for PolyPro® if it is not installed by a qualified professional installer.

DuraVent must be notified and given the opportunity to inspect defective product prior to replacement under the terms of this limited lifetime warranty. All warranty claims must be submitted with proof of purchase. Labor and installation costs are not covered under this warranty. To obtain warranty service contact: DuraVent Warranty Service, 877 Cotting Ct., Vacaville CA 95688, or call 800-835-4429.

WHERE LAWFUL, DURAVENT DISCLAIMS ALL OTHER WARRANTIES, INCLUDING BUT NOT LIMITED TO IMPLIED WARRANTIES OF MERCHANTABILITY AND FITNESS FOR A PARTICULAR PURPOSE. IN NO EVENT WILL DURAVENT BE LIABLE FOR INCIDENTAL, CONSEQUENTIAL, PUNITIVE OR SPECIAL DAMAGES OR DIRECT OR INDIRECT LOSS OF ANY KIND, INCLUDING BUT NOT LIMITED TO PROPERTY DAMAGE AND PERSONAL INJURY. DURAVENT'S ENTIRE LIABILITY IS LIMITED TO THE PURCHASE PRICE OF THIS PRODUCT. SOME STATES DO NOT ALLOW LIMITATIONS ON IMPLIED WARRANTIES, OR THE EXCLUSION OR LIMITATION OF INCIDENTAL OR CONSEQUENTIAL DAMAGES, SO THE ABOVE LIMITATIONS AND EXCLUSIONS MAY NOT APPLY TO YOU. THIS LIMITED WARRANTY GIVES YOU SPECIFIC LEGAL RIGHTS, AND YOU MAY ALSO HAVE OTHER RIGHTS THAT VARY FROM STATE TO STATE.

For the most up-to-date installation instructions, see [www.duravent.com](http://www.duravent.com)

REV 3.22.2012

M&G DuraVent, Inc. Vacaville CA 95688



For more information about PolyPro and to see an updated appliance approval list, scan qr tag or visit [duravent.com](http://duravent.com).

**DuraVent**  
Member of  M&G Group

800-835-4429  
[www.duravent.com](http://www.duravent.com)  
L275 6/2013

