



---

Installation, Operation & Maintenance Manual

# iSteam<sup>®</sup> 2.0 Control

mr.steam<sup>®</sup> | Feel Good Inc.

## READ ME FIRST!

**⚠️ WARNING** As you follow these instructions, you will notice warning and caution symbols. This blocked information is important for the safe and efficient installation and operation of this generator. These are types of potential hazards that may occur during installation and operation:

**⚠️ WARNING** Indicates a potentially hazardous situation, which, if not avoided, could result in death or serious injury.

**⚠️ CAUTION** Indicates a potentially hazardous situation, which, if not avoided may result in minor or moderate injury or product damage.

**IMPORTANT NOTE:** This highlights information that is especially relevant to a problem-free installation.

All information in these instructions is based on the latest product information available at the time of publication. Sussman-Automatic Corporation reserves the right to make changes at any time without notice.

When installing and using this electrical equipment, basic safety precautions should always be followed, including the following:

## IMPORTANT SAFETY INSTRUCTIONS

### 1. READ AND FOLLOW ALL INSTRUCTIONS

2. **⚠️ WARNING** Do not permit children under the age of 16 to use this steambath.
3. **⚠️ WARNING** Steam is hot and can cause injury or death if improperly used. Steam rooms contain steam and elevated temperatures. Please read and observe all warnings in this manual before installing or using a steam room.
4. **⚠️ WARNING** To reduce the risk of injury:
  - A. The wet surfaces of steam enclosures may be slippery. Use care when entering or leaving.
  - B. The steam head is hot. Do not touch the steamhead and avoid the steam near the steamhead.
  - C. Prolonged use of the steam system can raise excessively the internal human body temperature and impair the body's ability to regulate its internal temperature (hyperthermia). Limit your use of steam to 10-15 minutes until you are certain of your body's reaction.
  - D. Excessive temperatures have a high potential for causing fetal damage during the early months of pregnancy. Pregnancy or possibly pregnant women should consult a physician regarding correct exposure.
  - E. Obese persons and persons with a history of heart disease, low or high blood pressure, circulatory system problems, or diabetes should consult a physician before using a steambath.
  - F. Persons using medication should consult a physician before using a steambath since some medication may induce drowsiness while other medications may affect heart rate, blood pressure and circulation.

### SAVE THESE INSTRUCTIONS

**HYPERTHERMIA** occurs when the internal temperature of the body reaches a level several degrees above the normal body temperature of 98.6° F. The symptoms of hyperthermia include an increase in the internal temperature of the body, dizziness, lethargy, drowsiness, and fainting. The effects of hyperthermia include:

- a) Failure to perceive heat;
- b) Failure to recognize the need to exit the steambath;
- c) Unawareness of impending risk;
- d) Fetal damage in pregnant women;
- e) Physical inability to exit the steambath; and
- f) Unconsciousness.

### ⚠️ WARNING

The use of alcohol, drugs, or medication can greatly increase the risk of hyperthermia.

## Table of Contents:

Important Safety Instructions.....	2
Installation Template .....	2
Box Content .....	3
Dimensional Information .....	3
Before Installing.....	4
Locating the Control.....	5
Installation with Rough-In Box.....	5-6
Installation without Rough-In Box .....	6
iSteam® 2.0 Installation .....	7-8
Operating Instructions	
Stand-By, Start, Dashboard, Set Timer.....	9
Set Temperature, User Preferences .....	10
Accessories: AudioWizard®, AromaSteam, ChromaSteam®.....	10
Optional Accessories .....	11
Settings > Set Day/Time > Display.....	11
Setting > Language .....	11
Settings > Passcode .....	12
AutoStart .....	12
Care Tips, Safety & Operating Info .....	13
Warranty .....	13

## Box Contents:

- iSteam 2.0 Control
- Control Cable (30 ft.)
- Steamhead
- Tube of Silicone Sealant
- Owner's Manual
- Rough-In Box
- Optional Surface Mount Gasket

## Dimensional Information

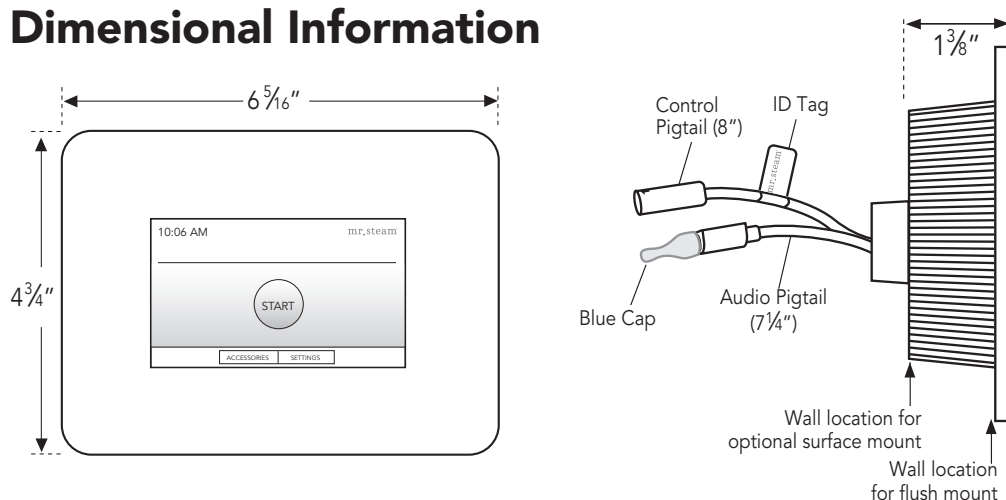

## Before Installing

**! WARNING** To avoid unintentional steambath operation, do not locate the control where other controls, accessories, shower heads, valves, body sprays or similar within the shower could cause confusion or interfere with the Mr.Steam control's intended use and function.

**! CAUTION**

- Do not use the iSteam 2.0 control without reading and understanding the Mr.Steam steam generator Installation and Operation Manual (PN 100472).
- A peel and stick warning sticker is provided in the Mr.Steam steam generator Installation, Operation and Maintenance Manual. This manual is provided with every steam generator. The warning sticker must be read and permanently affixed in a conspicuous location near the steam room. Failure to read and affix this warning sticker in a conspicuous location may result in serious injury or death. Please call Mr.Steam at 800 767-8326 for a free replacement or if you have any questions regarding the warning sticker.

<b>! WARNING</b>	
<b>REDUCE THE RISK OF OVERHEATING AND SCALDING</b>	
1. EXIT IMMEDIATELY IF UNCOMFORTABLE, DIZZY OR SLEEPY. STAYING TOO LONG IN A HEATED AREA IS CAPABLE OF CAUSING OVERHEATING.	
2. CHILDREN UNDER THE AGE OF 16 SHOULD NOT USE THE STEAM BATH.	
3. CHECK WITH A DOCTOR BEFORE USE IF PREGNANT, DIABETIC, IN POOR HEALTH OR UNDER MEDICAL CARE.	
4. BREATHING HEATED AIR IN CONJUNCTION WITH CONSUMPTION OF ALCOHOL, DRUGS, OR MEDICATION IS CAPABLE OF CAUSING UNCONSCIOUSNESS.	
5. DO NOT CONTACT STEAM HEAD OR STEAM AT THE STEAM HEAD.	
<b>REDUCE THE RISK OF SLIPPING AND FALL INJURY</b>	
1. USE CARE WHEN ENTERING OR EXITING THE STEAM ROOM. FLOOR MAY BE SLIPPERY	
NOTE: FOR ADDITIONAL SAFETY CONSIDERATIONS SEE OWNER'S MANUAL WHICH IS KEPT: _____	
THE OWNER'S MANUAL CAN BE FOUND AT WWW.MRSTEAM.COM OR BY SCANNING THE QR CODE.	
USE OF STEAM ROOM IN CONJUNCTION WITH CONSUMPTION OF ALCOHOL CAN BE DANGEROUS AND CAN RESULT IN INJURY THROUGH SLIP AND FALL OR OTHERWISE.	
<small>mr.steam® 43-20 34th Street, Long Island City NY 11101 1 800 76 STEAM www.mrsteam.com PUR100378 7/14</small>	

*Not actual size*

- If an iSteam 2.0 control is installed outside the steam room a Remote Temperature Probe (PN iMSTS) must be installed inside the steam room per installation instructions supplied with the Remote Temperature Probe. Failure to install according to instructions will result in an inoperative control and overheating of the steam room.

**! CAUTION** Do not route iSteam 2.0 control wiring inside conduit together with power lines or close to hot water or steam piping. Doing so may result in an inoperative or hazardous installation. Do not alter or modify any Mr. Steam products including the steam generator or iSteam 2.0 control. Doing so may result in an inoperative or hazardous installation and will void the warranty.

### IMPORTANT NOTES:

- The iSteam 2.0 Control is designed to be flush mounted. However, the control may be surface mounted when conditions permit. Consult a Mr.Steam Customer Service or Technical Service representative to determine if the iSteam 2.0 control can be surface mounted.
- Turn power to the steam generator OFF before connecting the control to the generator. Failure to turn the power off will result in an inoperable control.
- Do not operate the iSteam 2.0 control with other than a Mr.Steam iSteam 2.0 compatible steam generator. Mr.Steam residential steam generators with serial numbers lower than 930030, or any other brand of steam generator are not to be operated with iSteam 2.0 controls. Doing so may result in an inoperative installation. If your generator's serial number is lower than 930030 contact Mr.Steam Technical Service for upgrade options and components to enable your steam generator to function with iSteam 2.0.
- This document contains important safety, operation and maintenance information. Leave this document with the homeowner. Do not discard this document.
- Discontinue use of the steam generator or control if the steam generator is damaged or otherwise not functioning properly. Doing so may result in an inoperative or hazardous installation
- Refer to the Steambath Generator Installation, Operation and Maintenance Manual PN 100472 for locating and installing the steamhead.

**! WARNING** Do Not alter or modify any Mr.Steam products. Doing so may result in an inoperative or hazardous installation and will void the warranty.

## Locating the Control

Determine the desired installation location of the control. The iSteam 2.0 controls are designed to be installed inside or outside the steam room as a matter of personal preference. If the control is installed inside the steam room:

- Locate the control 4-5 feet above the floor near the bather seating area.
- The control features an integral temperature sensor. Locate the control in a location representative of the desired steam bathing temperatures. Do not locate the control above or near the steam head or direct steam emissions.
- Locate the control on a vertical wall.
- The control and AudioWizard® cables are 30 feet. Insure that the control, steam generator and optional AudioWizard are located accordingly.

### IMPORTANT NOTES:

- If required, contact Mr.Steam to purchase an optional 60' iSteam 2.0 control cable part number 104117-60.
- A 60 foot cable is NOT available for AudioWizard.
- If the control is installed outside the steam room a Remote Temperature Probe Part Number iMSTS must be installed inside the steam room. Refer to the iMSTS installation manual before installing the control.
- Insure Mr.Steam steam generator is iSteam 2.0 compatible and has a serial number 930030 or higher.

## Installation with Optional Rough-In Box

A rough-in box is supplied with iSteam 2.0 for new construction. The rough-in box will allow precise location of the iSteam 2.0 control and provide a secure and easily identifiable place for the cables while the steam room is being constructed.

**STEP 1** Take the rough-in box out of the package. Remove the two screws (1a) and place them in the top and bottom wings of the rough-in box (1b).

**STEP 2** Select a KNOCK-OUT (2a) to route the control cable into the box. Use a second KNOCK-OUT if the optional AudioWizard is used.

**STEP 3** Line up the two TABS (3a) on the right of the box against a stud. These TABS help locate the box to sit PROUD of the stud (3b).

**STEP 4** SCREW (4a) the two supplied screws into the stud.

**STEP 5** Route the CONTROL CABLE (5a) through the back of the rough-in box and clip it under one of the TABS (5b) that previously held the screws. The two ends of the control cable are the same.

**IMPORTANT NOTE:** The control cable should be run in a dedicated 1" conduit to facilitate installation and service.

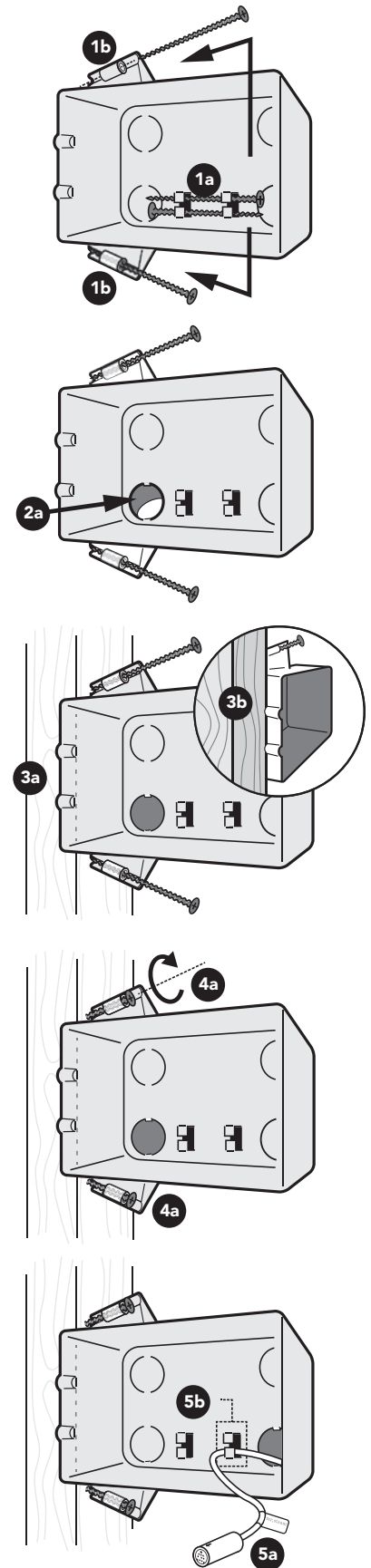

## Installation with Optional Rough-In Box (cont.)

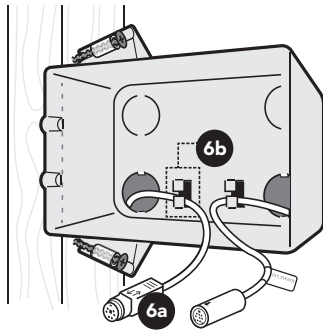

**IMPORTANT NOTE:** Be careful not to strain, staple, pinch or otherwise damage the cables. Route cables as required to permit replacement. Do not route cables inside conduit together with power lines or close to hot water or steam piping.

### STEP 6

When used, route the AudioWizard® Cable (6a) through a second knockout in the rough-in box and clip (6b). The two ends of the AudioWizard cable are the same. See the AudioWizard Installation Operation & Maintenance Manual (PUR 100478) for complete AudioWizard Installation instructions.

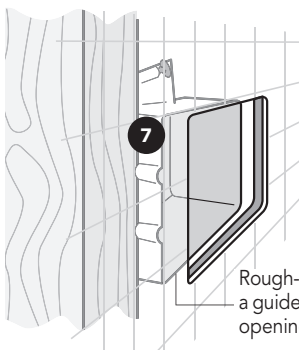

Rough-In box used as a guide to cut out the opening.

### STEP 7

Use the rough-in box as a guide to cut out the (3<sup>9</sup>/<sub>16</sub>" x 5<sup>1</sup>/<sub>4</sub>") opening in the wall.

Finish the iSteam 2.0 installation using the instructions on page 7.

## Installation without Rough-In Box

### STEP 1

Make a 3<sup>9</sup>/<sub>16</sub>" x 5<sup>1</sup>/<sub>4</sub>" cut-out in the desired location using the template provided on page 2 of this manual.

### STEP 2

Route the control cable from the wall cutout to the steam generator. Connect one end of the cable to the steam generator connector. The two ends of the control cable are the same.

### STEP 2

When used, route the AudioWizard® Cable from the wall cut-out to the AudioWizard. The two ends of the AudioWizard cable are the same. See the AudioWizard Installation Operation & Maintenance Manual (PUR 100478) for complete AudioWizard Installation instructions.

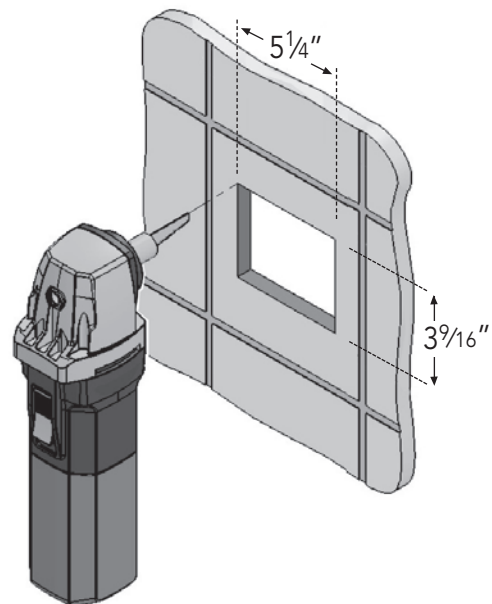

**IMPORTANT NOTE:** Be careful not to strain, staple, pinch or otherwise damage the control cable. Route cable as required to permit replacement. Do not route cable inside conduit together with power lines or close to hot water or steam piping.

Finish the iSteam 2.0 installation using the instructions on page 7.

## Installation Instructions for iSteam® 2.0

### STEP 1

PLUG the 30' control cable into the iSteam 2.0 control pigtail (1a). The iSteam 2.0 pigtail is the longer cable with the ID Tag.

If the optional AudioWizard® is used, remove the Red Cap from the AudioWizard pigtail (1b) and plug it into the AudioWizard cable.

See the AudioWizard Installation Operation and Maintenance Manual (PUR 100478) for complete AudioWizard Installation instructions.

Turn the generator on and test the control (and AudioWizard when installed) to verify correct connection. With proper function, proceed to Step 2.

**CAUTION** Do not force or twist cable ends together. Forcing or twisting cable ends may damage the connectors.

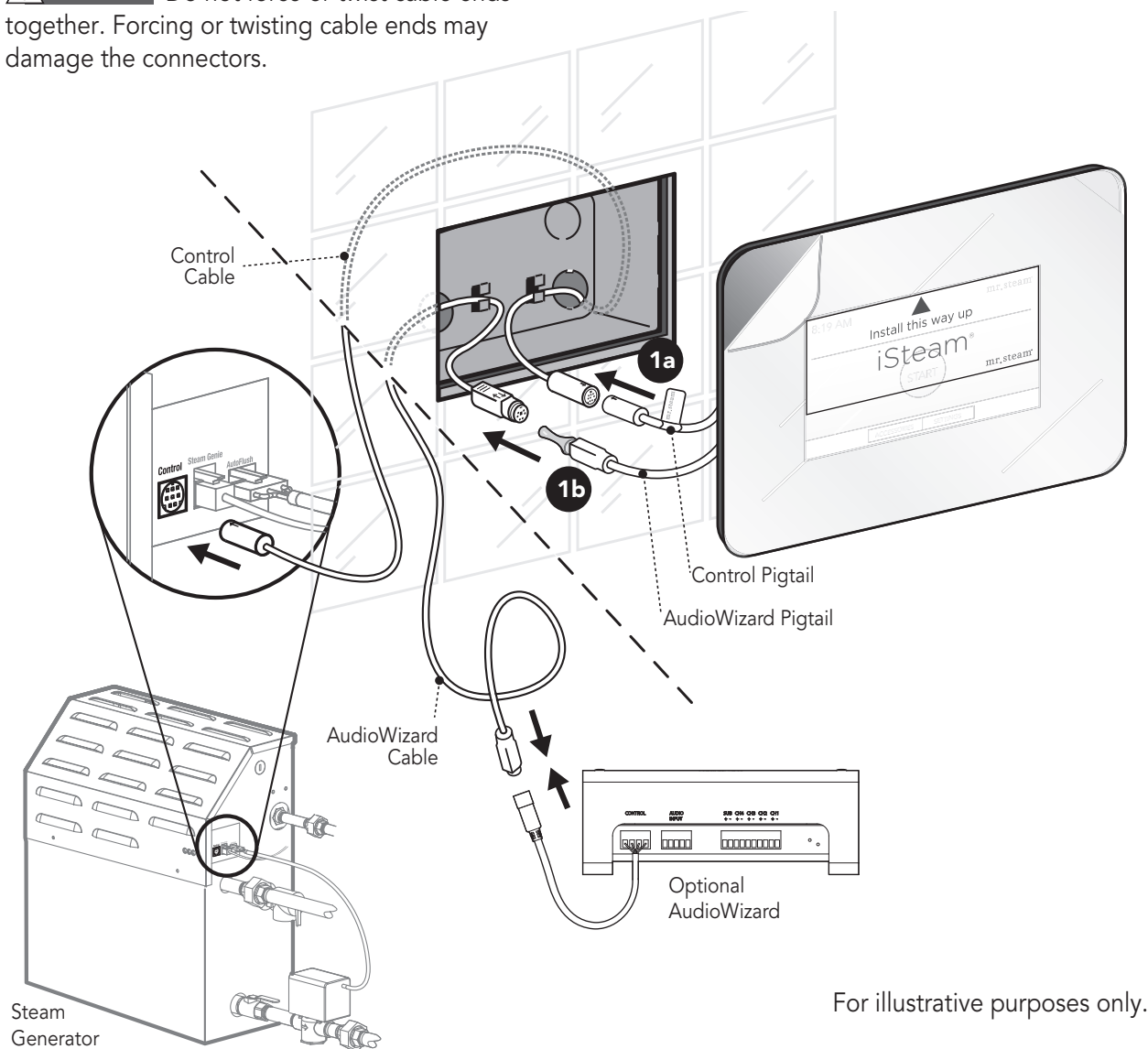

## Installation Instructions for iSteam® 2.0 (cont.)

### STEP 2

Peel the double stick adhesive off the back of the iSteam 2.0 control (2a). Apply a bead of silicone around the rear of the iSteam 2.0 control to create a moisture seal (2b). Carefully feed the cables into the rough-in box and secure the control to the wall. Care must be taken to not pinch the cables. Ensure the control is level.

**IMPORTANT NOTE:** The iSteam 2.0 control display reads in one direction only. The control must be installed with the arrow on the Peel-Off screen protector facing up. If the Peel-Off screen protector has been removed see the drawing in Step 2b for the proper orientation.

**NOTE:** The silicone supplied by Mr. Steam® can be used to meet a variety of sealing and gasketing. It cures to silicone rubber and adheres to glass, wood, metal, porcelain, ceramic tile, painted surfaces, many plastics and rubber. Surfaces must be clean and dry. Apply thin layer of product. Fit together and support if necessary. Allow excess material to cure, then trim with a sharp blade. Sealant "skins" in 5 minutes, dries to touch in 1 hour. Fully cures and bonds in 24 hrs.

**IMPORTANT NOTE:** Do not apply excessive amounts of silicone. Do not apply silicone to any other parts of the control including the adhesive gasket. Insure the mounting surface is clean and dry as required for good adhesion. Hold the control with the arrow on the screen protector facing up and press the control against the wall until the adhesive sticks and holds firmly. Control may have to be supported or secured until the silicone has cured for 24 hours.

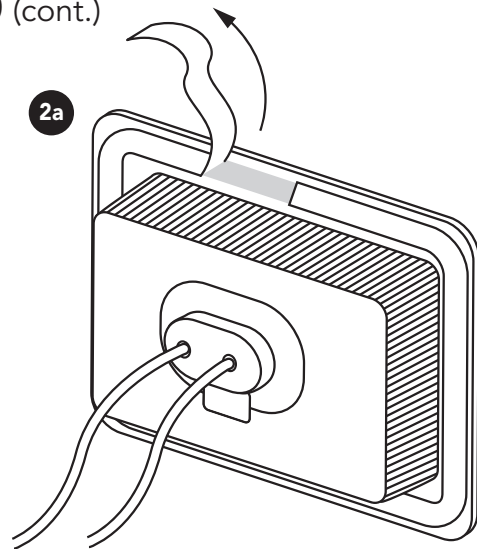

2a

2b

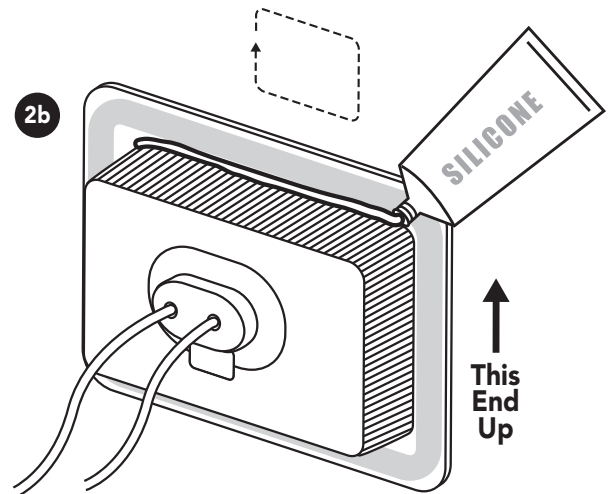

↑  
This End Up

2c

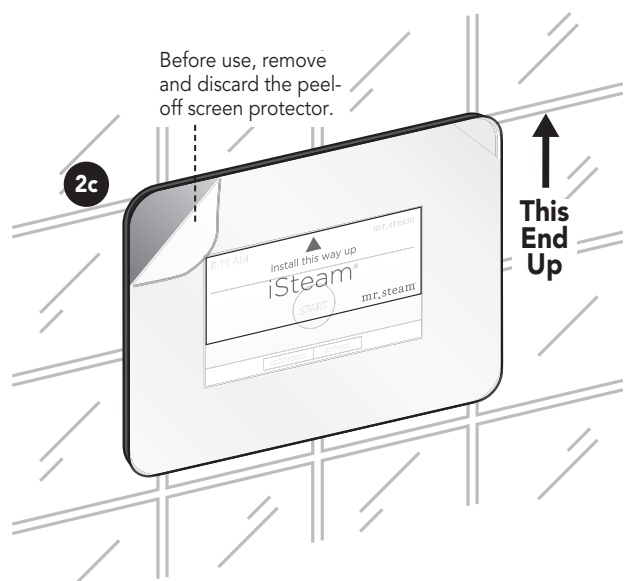

↑  
This End Up

Before use, remove and discard the peel-off screen protector.

## Operating Instructions

**!WARNING** Set the steam bathing duration and temperature according to personal preference, however it is highly recommended to begin steam bathing at a low temperature setting to gauge comfort and safety levels. Set the duration at 10 minutes max. to gauge comfort and safety levels. This will allow the steam generator to heat up and begin producing steam.

### Stand-By Screen

Touch anywhere on the display to wake up the iSteam® 2.0 Control

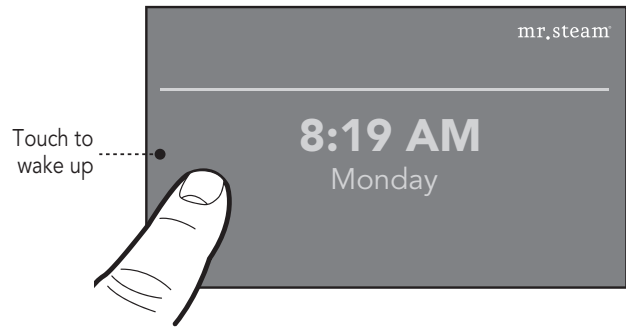

### Start Screen

Press the START button to turn the steam generator ON and to display the Dashboard screen. Steam will begin to flow a few minutes after the START button is pressed. The time required for the steam room to reach steam bathing temperatures depends on the steam room construction and steam generator specifications.

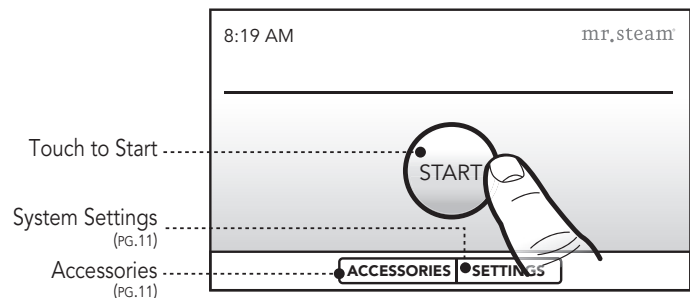

### Dashboard Screen

The Dashboard displays key steam bathing features and optional accessories in one convenient screen. The key features include TIME, TEMPERATURE and USER settings. The optional accessories include the ChromaSteam®, AromaSteam and AudioWizard®.

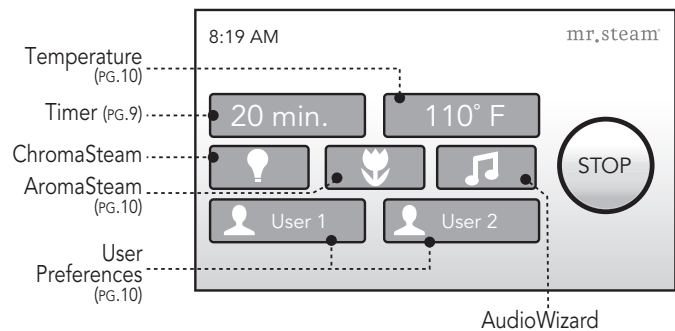

### Set Timer Screen

Press the TIMER button on the Dashboard to access the SET TIMER screen. Swipe your finger from left to right to select the desired time (1-60 minutes). Press CANCEL to return to the Dashboard without changing the time. Press HOME to return to the Dashboard, saving the time for this steambath session only. Press SAVE to save the time setting as the new default or as the selected user setting. The control will turn off when the steambath session times out. Then the START screen will be displayed.

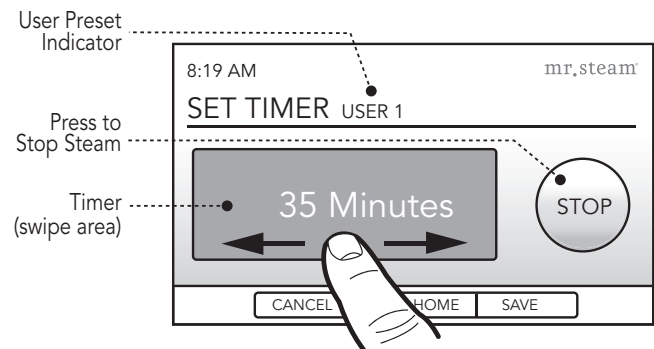

### Set Temperature Screen

Press the TEMPERATURE button on the Dashboard to access the SET TEMPERATURE screen.

The control is preset and will display a temperature setting of 110°F (default setting). Swipe your finger from left to right to adjust the desired temperature (80° - 120°F) in one degree increments.

Press CANCEL to return to the Dashboard without changing the time. Press HOME to return to the Dashboard, saving the time for this steambath session only. Press SAVE to save the time setting as the new default or as the selected user setting.

### Changing the Temperature Units (°F/°C)

Press the UNITS button in the lower right corner of the SET TEMPERATURE screen to change from Fahrenheit to Celsius. Press the SAVE button to accept the new value and exit.

### Memory Feature

If the control is turned off manually before it times out then the default settings of 20 minutes and 110°F will

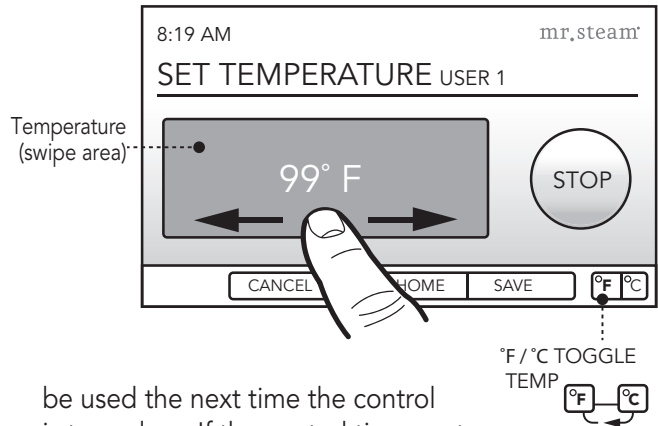

be used the next time the control is turned on. If the control times out (not manually turned off) then the previous user time and temperature settings will be used when the steambath is used again.

### User Preferences (User1 and User2 )

Press USER 1/USER 2 button. Enter the preferred time and temperature settings and press SAVE. iSteam 2.0® will automatically save the settings. To recall the user preferences press USER 1/USER 2 the next time the steambath is used.

## AudioWizard® 2.0

### iSteam® 2.0 Interface

Press the MUSIC button to access the AudioWizard screen. The AudioWizard will automatically turn on when audio is sent to it. AudioWizard automatically enters sleep mode 2 minutes after music stops.

- Previous Track (Bluetooth® only)
- Play/Pause (Bluetooth only)
- Next Track (Bluetooth only)
- Increase Volume
- Decrease Volume
- Return to Previous Screen
- Bluetooth Pairing Button

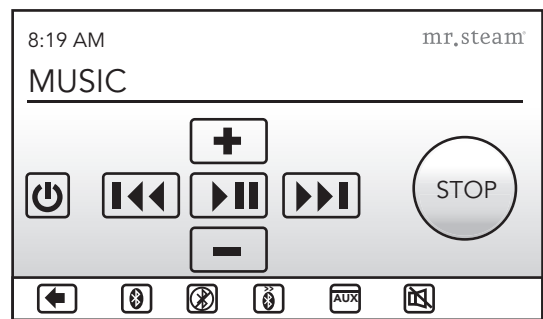

If you are using a Bluetooth audio source, it must be connected for functions to work. Please refer to the Bluetooth® pairing instructions in this manual. Please note that the Play/Pause and Change Track functions apply to Bluetooth only, and will not work when playing audio from a hard wired music source.

### AromaSteam

The AromaSteam is optional accessory that automatically infuses aromatic oils into the steam flow. Press the AROMA button to turn it ON. The AromaSteam turns OFF automatically when the steam generator stops. Press the AROMA button to turn it OFF during a steam session.

### ChromaSteam®

The ChromaSteam is an optional accessory that activates colored lights in the steam room. Press the CHROMA button to turn it ON. Turn the button OFF then back ON to select the desired color. Press again to turn the lights OFF.

### Optional Accessories Screen

Press the ACCESSORIES button on the START screen to access the optional ChromaSteam® and AudioWizard® accessories when a steam-bath is not in session.

See page 10 for information on the ChromaSteam and AudioWizard operation.

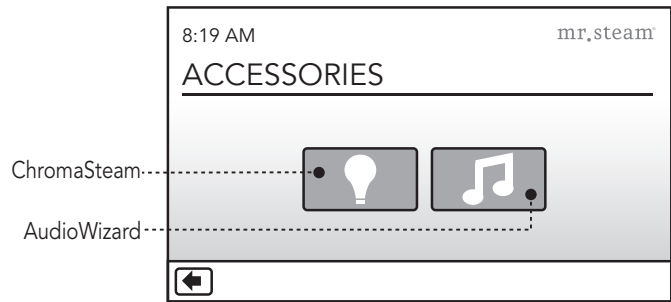

### Settings Screen

The Setting Screen allows access to less frequently used screens including the setting of DAY/TIME, DISPLAY BRIGHTNESS, PASSCODE LOCK, SYSTEM RESET, and LANGUAGE.

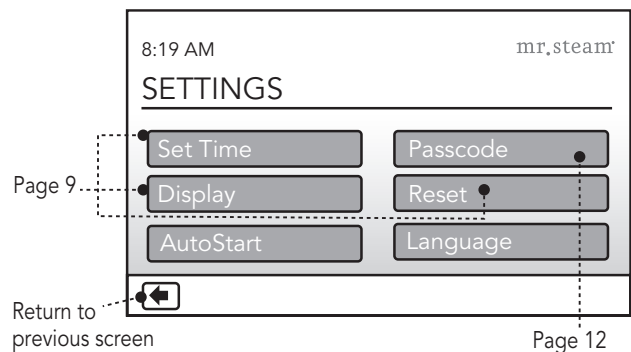

### Settings > Set Day/Time

Access the system SETTINGS screen by pressing the button on the start screen. To set the TIME, press the parameter (HOURS, MINUTES, AM/PM, DAY) to be adjusted. Use the UP/DOWN arrows to change. Press the SAVE button to save the time. Press the CANCEL button to exit without saving the changes. Press the HOME button to return to the SETTINGS screen.

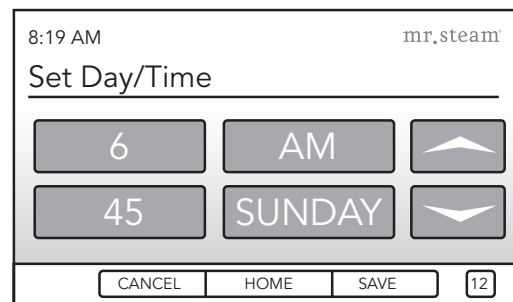

Press to change from 12 to 24 hr. clock

### Settings > Display

To adjust the screen brightness swipe your finger as shown. The "OFF" screen can display the clock, remain blank until touched, or be the START screen by using the buttons shown. A screen saver can be turned ON/OFF using the button shown. When ON, the display will automatically dim after it has been on for 1 hour.

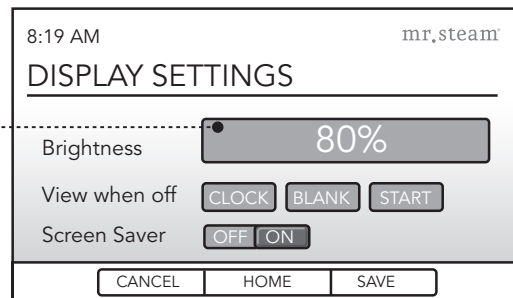
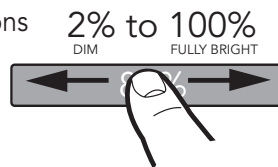

### Settings > Language

To change the language used in iSteam press the LANGUAGE button in the settings screen. Select the language you would like to use by taping it. Press SAVE to confirm the language change.

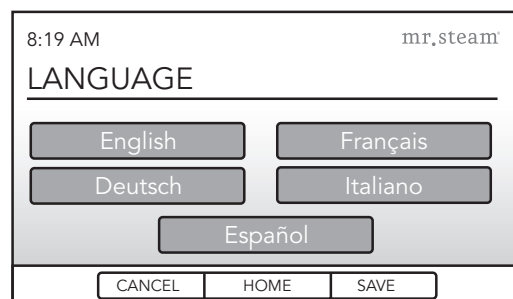

## Settings > Passcode

The Passcode feature can help prevent unintentional use of the steambath. Please refer to the steam generator Installation, Operation and Maintenance manual (PN 100472) before using the steam bath. The Passcode feature cannot insure unintentional use of the steambath.

Enter a 4 digit passcode using the keypad. Press the passcode lock button ON under the 4 digit code to turn the passcode lock on. Press SAVE to store the passcode. The next time the iSteam 2.0® control is turned on the user will be prompted to enter the passcode. Press CANCEL to exit without storing the passcode lock.

If you forget your passcode, power should be turned off at the circuit breaker. After 1 minute turn the breaker back on. The passcode lock will automatically be turned OFF.

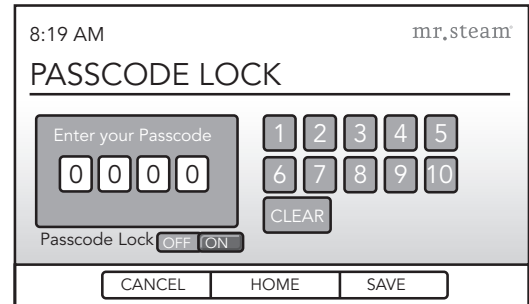

## AutoStart

**!WARNING** AutoStart will automatically turn the steam generator on at your preset time. Activating the steam in an occupied room may subject persons to the hazards described in this manual. Only activate the steambath if the steam room door is closed. Activating or using the steambath with an open door may cause property damage or injury to persons outside of the steam bath.

The AutoStart feature can be used to turn on the steambath at a predetermined time. Select the day(s) of the week and the time of day you would like to turn the steam bath on. You can also set the ChromaSteam® and AromaSteam to turn on.

To activate AutoStart, slide the switch to the ON position and press save. When AutoStart is armed you will see a  in the upper right corner of the screen.

When AutoStart starts your steambath it will allow the steambath to run for only 10 minutes. To continue steam bathing press the continue button. If the continue button is pressed, AutoStart will remain active for the next scheduled start time.

To stop the steam bath press the stop button. If the ON button is pressed within 10 minutes the steambath will turn off. If the STOP button or 10 minute time out turns the steam generator off, AutoStart will automatically be deactivated.

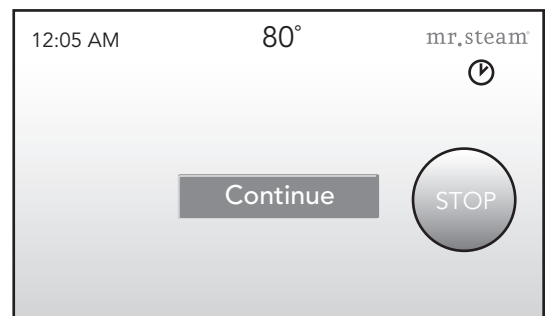
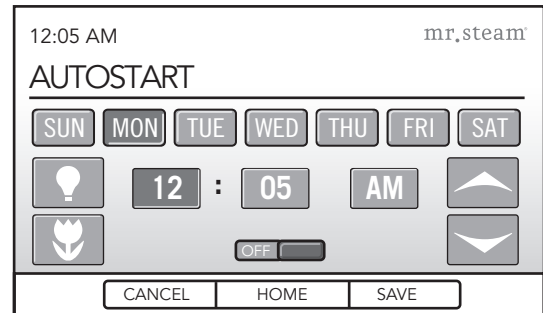

## Care Tips

Use only mild soap and water on a soft cloth to clean the control. Do not use abrasive cleansers

## Safety and Operating Information

**! WARNING** Set the steam bathing duration and temperature according to personal preference, however it is highly recommended to begin steam bathing at a low temperature setting to gauge comfort and safety levels. Set the duration at 10 minutes max. to gauge comfort and safety levels. This will allow the steam generator to heat up and begin producing steam.

**! CAUTION** Do not use any iSteam® 2.0 control without reading and understanding the Mr.Steam® steam generator Installation and Operation Manual (PN 100472). Failure to read and understand these instructions may result in an inoperative or hazardous installation.

**! CAUTION**

A peel and stick warning sticker is provided in the Mr.Steam steam generator Installation, Operation and Maintenance Manual. This manual is provided with every steam generator. The warning sticker must be read and permanently affixed in a conspicuous location near the steam room. Failure to read and affix this warning sticker in a conspicuous location may result in serious injury or death. Please call Mr.Steam at 800 767-8326 for a free replacement or if you have any questions regarding the warning sticker.

**! CAUTION**

If an iSteam 2.0 control is installed outside the steam room a Remote Temperature Probe (PN iMSTS) must be installed inside the steam room per installation instructions supplied with the Remote Temperature Probe. Failure to install according to instructions will result in an inoperative control and overheating of the steam room.

---

## Warranty

To view or download the Mr. Steam® Control Warranty and register your product go to: [blog.mrsteam.com/wr](http://blog.mrsteam.com/wr)



# mr.steam®

Feel Good Inc.

[www.mrsteam.com](http://www.mrsteam.com)

---

Products, information and specifications are subject to change without notice. For more information call Sales & Support at 1.800.76.STEAM (East Coast) or 1.800.72.STEAM (West Coast) for more information.

---

**mr.steam®** Sussman-Automatic Corporation® | [hello@mrsteam.com](mailto:hello@mrsteam.com) | [www.mrsteam.com](http://www.mrsteam.com)

43-20 34th Street, Long Island City, NY 11101 | 9410 S. La Cienega Blvd. Inglewood CA 90301

1 800 767 8326 FAX: 718 472 3256 | 1 800 72 STEAM FAX: 310 216 2944

---

2015 © Sussman-Automatic Corporation | Mr.Steam and des., A Lifetime of Pleasure, AromaFlo, AudioWizard, AutoFlush, AutoSteam, Butler Package, ChromaSteam, Clean Steam...Every Time, Club Therapy, Digital 1, Express Steam, Feel Good Inc., From Bathroom to Spa, iButler, iGenie, iSizing, iSteam, Making Wellness a Way of Life, Music Therapy, Spa Package, Steam Genie, Steam on Demand, Steam@Home, iTempo, iTempo/Plus, SmartSizing, SteamStart, SteamStop, SteamTherapy, Sussman, Tala, The Intelligent Steambath, Valet Package, Virtual Spa System, Voice Genie and Voice Wizard are registered trademarks of Sussman-Automatic Corporation. AirTempo and Bath & Body Therapy are trademarks of Sussman-Automatic Corporation.

PUR 100489A REV 11.15