

PWR WTR HTR

⚠ DANGER
 Hazardous Voltage.
 Turn off power
 before opening
 cover. Serviceable
 only by licensed
 electrician.

⚠ DANGER
 Tension électrique
 dangereuse. Couper
 l'alimentation avant
 l'ouverture du
 couvercle. Entendre par
 un électricien qualifié
 agréé uniquement.

mr.steam®
 Feel Good Inc.®

⚠ WARNING

- Do not install shutoff valve on the steam outlet
- Do not install in any location where water can freeze
- Not for space heating purposes
- See installation instructions
- For residential use only

Generator must be installed with arrow facing the generator must be level from side to side and front to back.

⚠ AVERTISSEMENT

- Ne pas installer les raccords de la valve d'arrêt sur le joint de sortie de la vapeur.
- Ne pas installer dans des endroits où l'eau pourrait geler.
- A ne pas utiliser comme appareil de chauffage.
- Voir guide d'installation.
- Pour un usage résidentiel.

Le générateur doit être installé en ayant la flèche pointant vers le fond. Le générateur doit être mis au niveau de chaque côté et de l'avant à l'arrière.

CUSTOMER & TECH SUPPORT

USA: 1-800-854-3863
 1801 S. California Street
 Long Beach, CA 90801

CANADA: 1-800-854-3863
 1801 S. California Street
 Long Beach, CA 90801

QUICK SET UP GUIDE

GENERATOR | CONTROLS | ACCESSORIES



For illustrative purposes only.



CONTENTS

GENERATOR LOCATION	5
POWER CONNECTION	6
WATER FEED	7
STEAM OUTLET	7
DRAIN LINE	7
AUTOFLUSH®	8
CONDENSATION PAN	9
LIQUID LEVEL CONTROL BOARD	9
MAX GENERATOR INSTALLATION	10
GENERATOR	11
STEAM CONTROL LOCATION	15
iSTEAM®X STEAMHEAD INSTALLATION LOCATION	16
iSTEAM®X CONTROL INSTALLATION	17
AIRTEMPO® CONTROL INSTALLATION	19
AIRTEMPO® WIRELESS RECEIVER/ FLUSH MOUNT INSTALLATION	20
iTEMPO® OR ITEMPO/PLUS® CONTROL INSTALLATION	23
REMOTE TEMPERATURE PROBE INSTALLATION	24
CONTROL CABLE TO THE STEAM GENERATOR CONNECTION	26
AROMASTEAM SYSTEM	29
AROMASTEAM STEAMHEAD	31
USING ESSENTIAL OILS	32
LINEAR STEAMHEAD	33
FACEPLATE	35
DIVERTER	35
AROMATRAY	36
CHROMASTEAM®X	37
CHROMASTEAM72	40
AUDIO@HOME	41
MS-SPEAKER	42
SHOWER SEAT	44
STEAMLINX® MOBILE APP	46
TYPICAL INSTALL OF DREAM PACKAGE SCHEMATIC	48

KEY SIGNAL WORDS

⚠️WARNING As you follow these instructions, you will notice warning and caution symbols. This blocked information is important for the safe and efficient installation and operation of this generator. These are types of potential hazards that may occur during installation and operation:

⚠️WARNING Indicates a potentially hazardous situation, which, if not avoided, could result in death or serious injury.

⚠️CAUTION Indicates a potentially hazardous situation, which, if not avoided may result in minor or moderate injury or product damage.

IMPORTANT NOTE: This highlights information that is especially relevant to a problem-free installation.

All information in these instructions is based on the latest product information available at the time of publication. MrSteam reserves the right to make changes at any time without notice. More current instructions may be available at www.mrsteam.com.

⚠️WARNING The information in this guide is designed to provide a general overview of how MrSteam® products are installed. All images and diagrams are for illustrative purposes only and may have been altered for presentation purposes. NEVER use this document for the Installation, Operation or Maintenance of any MrSteam® product. For installation, operation and maintenance information and instructions, only use the applicable MrSteam® Installation, Operation & Maintenance Manual(s). The specific Installation, Operation & Maintenance manual that is supplied with each MrSteam® product contains important information required for the safe and reliable installation and operation of the product. Failure to install any MrSteam® product according to the applicable manual may result in property damage, an inoperable system/control, or hazardous condition. If you do not have the applicable Installation, Operation & Maintenance manual please contact MrSteam® for a free copy, or download a copy from www.mrsteam.com. If you have any questions about the installation, operation or maintenance of any MrSteam® product please contact a customer or technical service representative using the contact information on the back cover of this guide or consult a properly licensed contractor, architect and/or design professional.

SUBJECT TO CHANGE WITHOUT NOTICE.



MR.STEAM® GENERATOR INSTALLATION

LOCATING THE MR.STEAM® GENERATOR

Select a location as near as practical to the steam room. Typical locations include: closet, vanity cabinet, climate controlled attic or basement.



Locate steambath generator as close to shower as possible.
30ft cable is included.
Optional 60ft cable available
*See control section for special control cable installation.

⚠WARNING The information in this guide is designed to provide a general overview of how MrSteam® products are installed. All images and diagrams are for illustrative purposes only and may have been altered for presentation purposes. NEVER use this document for the Installation, Operation or Maintenance of any MrSteam® product. For installation, operation and maintenance information and instructions, only use the applicable MrSteam® Installation, Operation & Maintenance Manual(s). The specific Installation, Operation & Maintenance manual that is supplied with each MrSteam® product contains important information required for the safe and reliable installation and operation of the product. Failure to install any MrSteam® product according to the applicable manual may result in property damage or an inoperable or hazardous condition. If you do not have the applicable Installation, Operation & Maintenance manual please contact MrSteam® for a free copy, or download a copy from www.mrsteam.com. If you have any questions about the installation, operation or maintenance of any MrSteam® product please contact a customer or technical service representative using the contact information on the back cover of this guide or consult a properly licensed contractor, architect and/or design professional.

FIELD POWER SUPPLY CONNECTION

Please refer to the wiring diagram in the Mr.Steam Installation Manual for complete wiring information.

MAIN ELECTRICAL DISCONNECT PANEL

HIGH VOLTAGE POWERLINE

TO AVOID EQUIPMENT DAMAGE DO NOT CONNECT POWER SUPPLY DIRECTLY TO THE HEATING ELEMENTS!!!

⚠WARNING The information in this guide is designed to provide a general overview of how MrSteam® products are installed. All images and diagrams are for illustrative purposes only and may have been altered for presentation purposes. NEVER use this document for the Installation, Operation or Maintenance of any MrSteam® product. For installation, operation and maintenance information and instructions, only use the applicable MrSteam® Installation, Operation & Maintenance Manual(s). The specific Installation, Operation & Maintenance manual that is supplied with each MrSteam® product contains important information required for the safe and reliable installation and operation of the product. Failure to install any MrSteam® product according to the applicable manual may result in property damage or an inoperable or hazardous condition. If you do not have the applicable Installation, Operation & Maintenance manual please contact MrSteam® for a free copy, or download a copy from www.mrsteam.com. If you have any questions about the installation, operation or maintenance of any MrSteam® product please contact a customer or technical service representative using the contact information on the back cover of this guide or consult a properly licensed contractor, architect and/or design professional.

WATER FEED

1. Connect to cold water line.
2. Provide a shut off valve, and a copper or brass union on the water supply line.
3. Flexible copper tubing, braided hose, PVC or PEX if permissible by local codes.



STEAM OUTLET PIPE

1. Provide a 1/2" copper or brass union on steam line.
2. Pitch steam line 1/4" per foot towards steam head or steam generator to avoid valleys and trapping of condensate.



NOTE: Running the steam line down and then up will create a steam trap blocking the flow of steam.

MANUAL DRAIN LINE

1. Drain (1/2" NPT).
2. Unit drains by gravity.
3. Provide 1/2" copper or brass union.

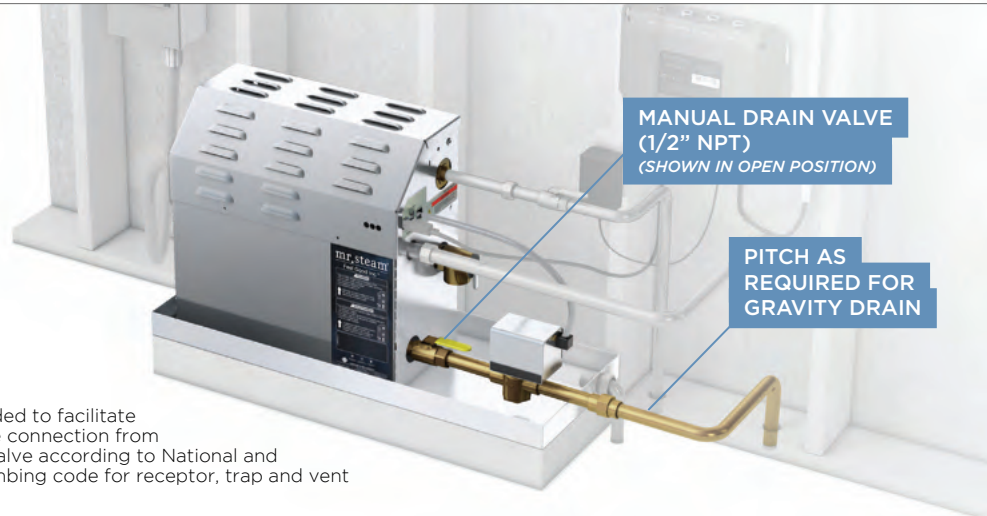

NOTE: A drain valve is provided to facilitate servicing. Provide a drain line connection from steambath generator drain valve according to National and local Codes. Check local plumbing code for receptor, trap and vent requirements.

⚠WARNING The information in this guide is designed to provide a general overview of how MrSteam® products are installed. All images and diagrams are for illustrative purposes only and may have been altered for presentation purposes. NEVER use this document for the Installation, Operation or Maintenance of any MrSteam® product. For installation, operation and maintenance information and instructions, only use the applicable MrSteam® Installation, Operation & Maintenance Manual(s). The specific Installation, Operation & Maintenance manual that is supplied with each MrSteam® product contains important information required for the safe and reliable installation and operation of the product. Failure to install any MrSteam® product according to the applicable manual may result in property damage or an inoperable or hazardous condition. If you do not have the applicable Installation, Operation & Maintenance manual please contact MrSteam® for a free copy, or download a copy from www.mrsteam.com. If you have any questions about the installation, operation or maintenance of any MrSteam® product please contact a customer or technical service representative using the contact information on the back cover of this guide or consult a properly licensed contractor, architect and/or design professional.

OPTIONAL AUTOFLUSH®

OPERATION

The optional AutoFlush® System automatically drains the Mr.Steam® system following each use. A time delay allows the water to cool down (about two hours) before it drains by gravity for a safe and gentle operation.

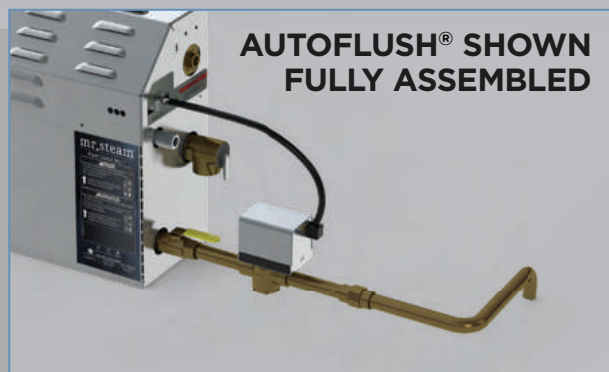
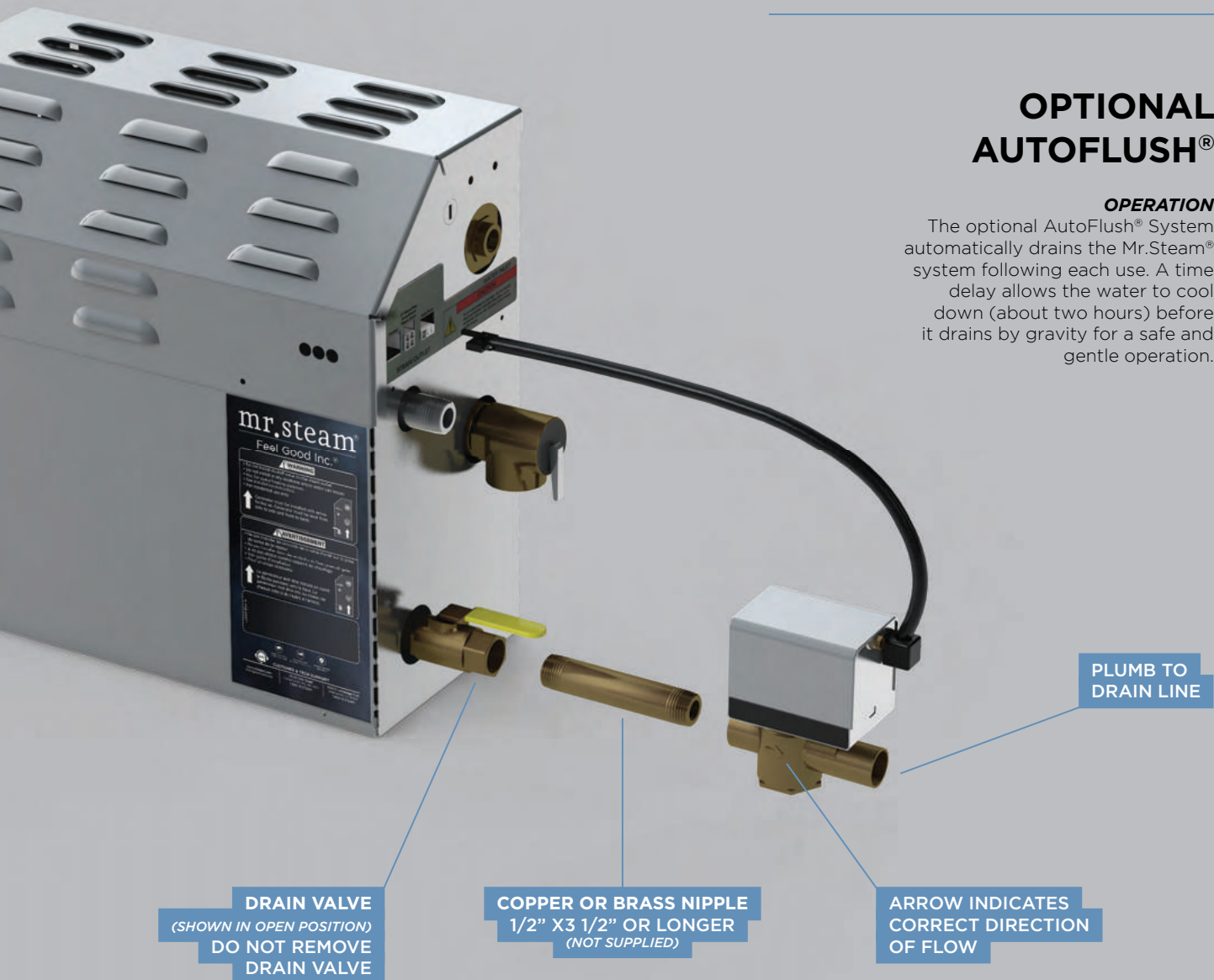

CAUTION: PROVIDE DRAIN PLUMBING ACCORDING TO NATIONAL AND LOCAL CODES. PLUMB AS REQUIRED FOR AUTOFLUSH® SYSTEM.

⚠️WARNING The information in this guide is designed to provide a general overview of how MrSteam® products are installed. All images and diagrams are for illustrative purposes only and may have been altered for presentation purposes. NEVER use this document for the Installation, Operation or Maintenance of any MrSteam® product. For installation, operation and maintenance information and instructions, only use the applicable MrSteam® Installation, Operation & Maintenance Manual(s). The specific Installation, Operation & Maintenance manual that is supplied with each MrSteam® product contains important information required for the safe and reliable installation and operation of the product. Failure to install any MrSteam® product according to the applicable manual may result in property damage or an inoperable or hazardous condition. If you do not have the applicable Installation, Operation & Maintenance manual please contact MrSteam® for a free copy, or download a copy from www.mrsteam.com. If you have any questions about the installation, operation or maintenance of any MrSteam® product please contact a customer or technical service representative using the contact information on the back cover of this guide or consult a properly licensed contractor, architect and/or design professional.

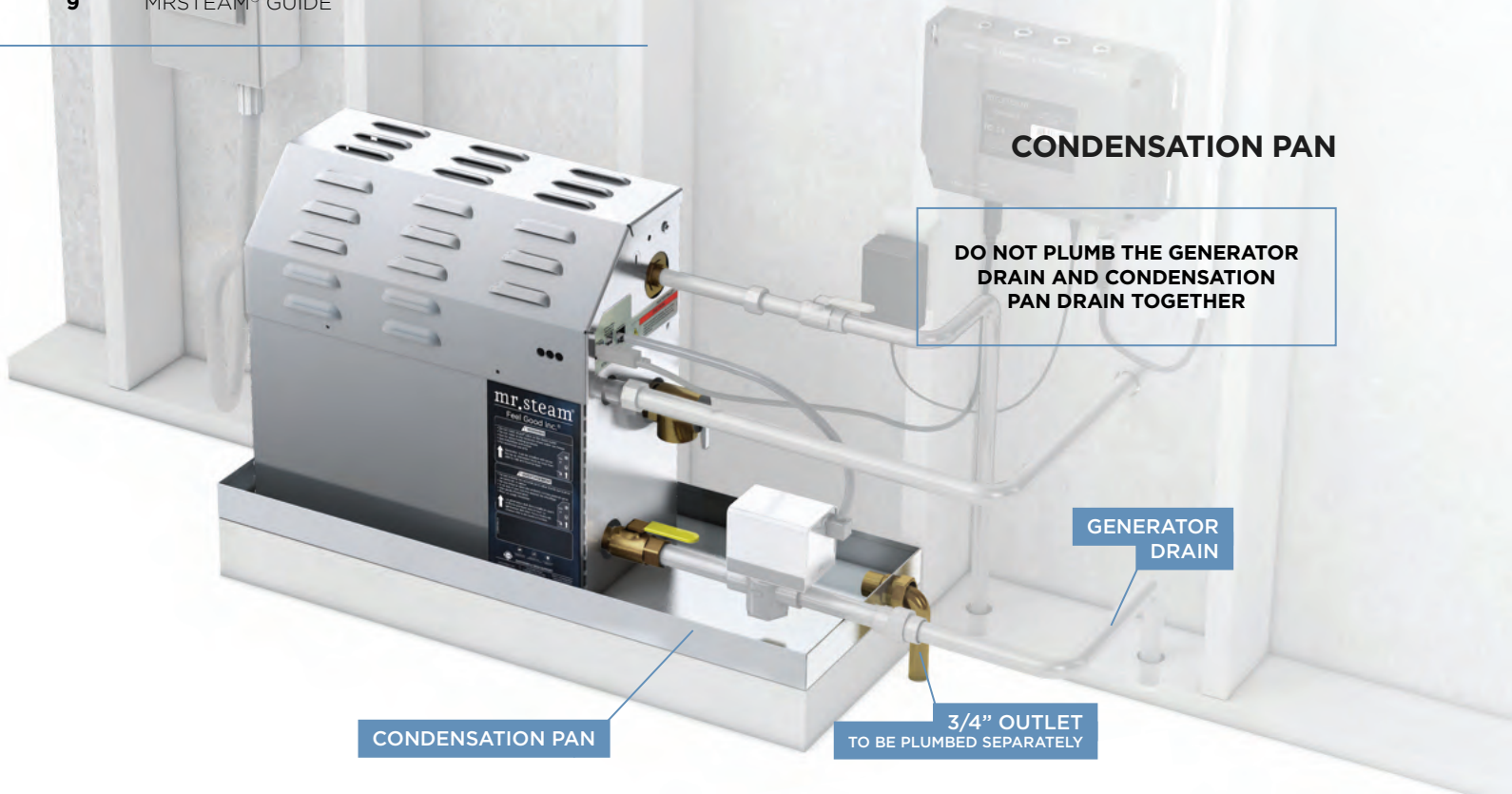

LIQUID LEVEL CONTROL BOARD

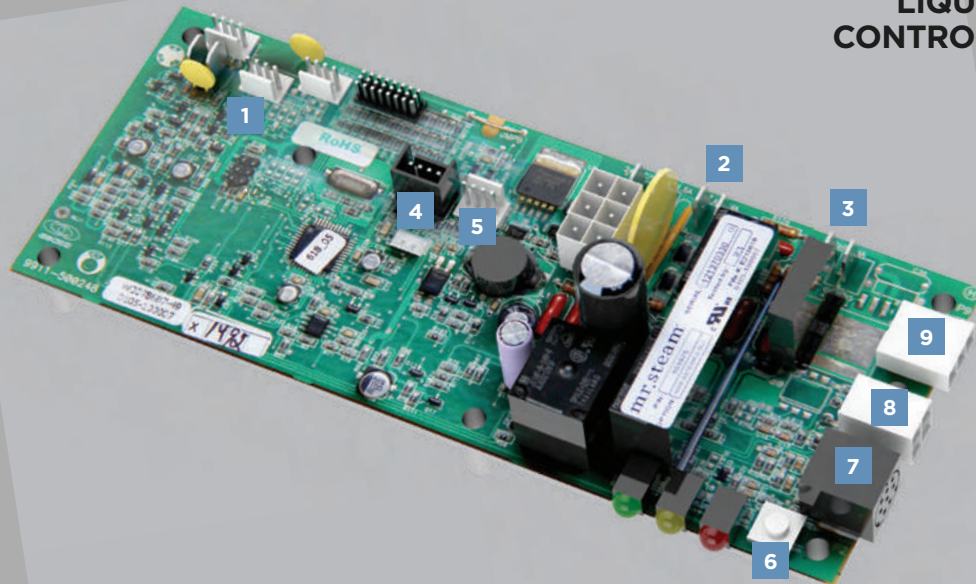

- | | |
|--|-----------------------------------|
| 1 SteamLinx A Cable Connection | 7 Control Cable Connection |
| 2 AromaSteam 1/4" Spade Terminal Connection | 8 Home Wizard Connection |
| 3 Chroma72 1/4" Spade Terminal Connection | 9 AutoFlush Connection |
| 4 MSTs (Remote Temperature Sensor) Connection | |
| 5 Tandem Connection (for two generators) | |
| 6 Test Button | |

⚠WARNING The information in this guide is designed to provide a general overview of how MrSteam® products are installed. All images and diagrams are for illustrative purposes only and may have been altered for presentation purposes. NEVER use this document for the Installation, Operation or Maintenance of any MrSteam® product. For installation, operation and maintenance information and instructions, only use the applicable MrSteam® Installation, Operation & Maintenance Manual(s). The specific Installation, Operation & Maintenance manual that is supplied with each MrSteam® product contains important information required for the safe and reliable installation and operation of the product. Failure to install any MrSteam® product according to the applicable manual may result in property damage or an inoperable or hazardous condition. If you do not have the applicable Installation, Operation & Maintenance manual please contact MrSteam® for a free copy, or download a copy from www.mrsteam.com. If you have any questions about the installation, operation or maintenance of any MrSteam® product please contact a customer or technical service representative using the contact information on the back cover of this guide or consult a properly licensed contractor, architect and/or design professional.

NEW

MAX STEAM GENERATOR INSTALLATION

(MX 4E, 5E & 6E)

**DO NOT INSTALL IN VANITY OR
OTHER SMALL SPACES**

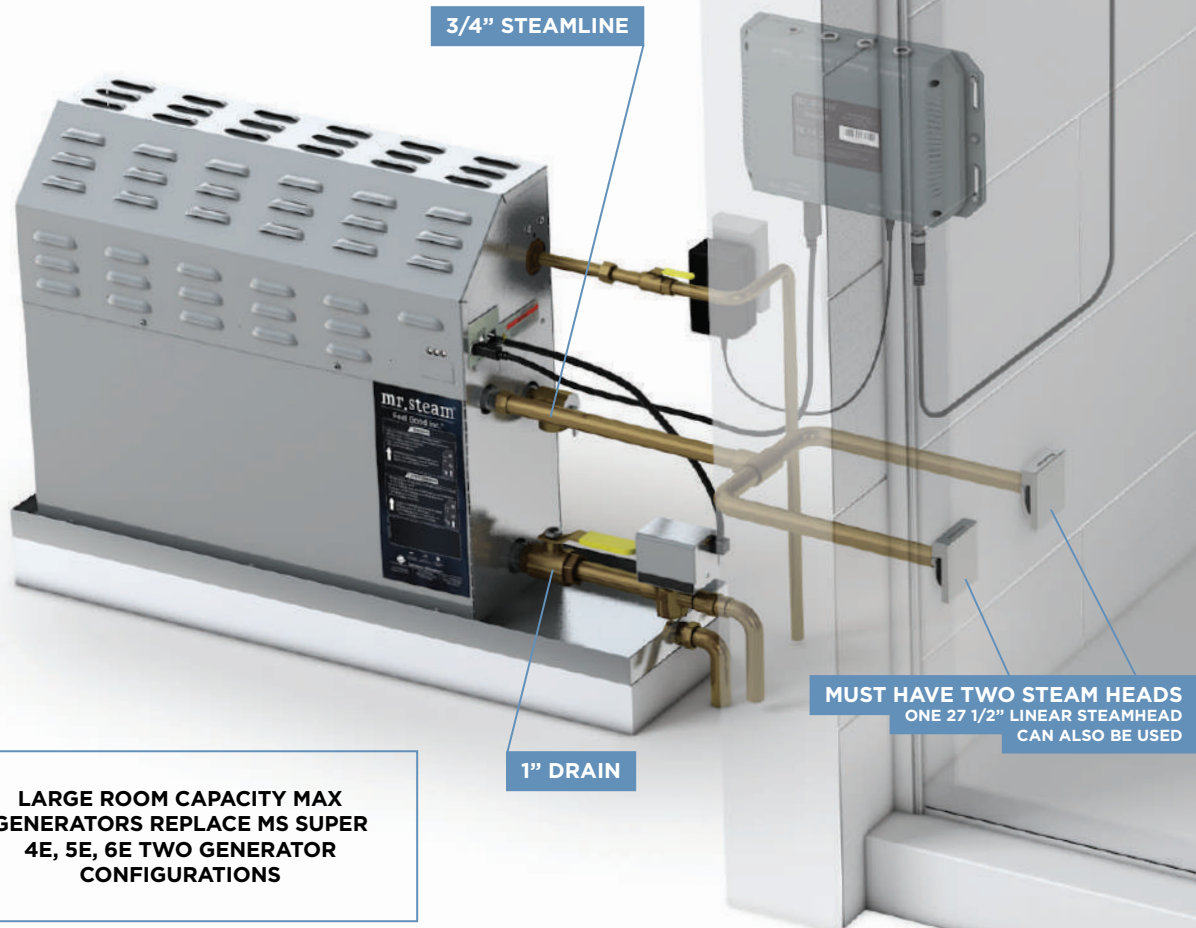

3/4" STEAMLIN

1" DRAIN

MUST HAVE TWO STEAM HEADS
ONE 27 1/2" LINEAR STEAMHEAD
CAN ALSO BE USED

**LARGE ROOM CAPACITY MAX
GENERATORS REPLACE MS SUPER
4E, 5E, 6E TWO GENERATOR
CONFIGURATIONS**

Refer to the Mr.Steam MAX Installation manual for additional installation information.

⚠️WARNING The information in this guide is designed to provide a general overview of how Mr.Steam® products are installed. All images and diagrams are for illustrative purposes only and may have been altered for presentation purposes. NEVER use this document for the Installation, Operation or Maintenance of any Mr.Steam® product. For installation, operation and maintenance information and instructions, only use the applicable Mr.Steam® Installation, Operation & Maintenance Manual(s). The specific Installation, Operation & Maintenance manual that is supplied with each Mr.Steam® product contains important information required for the safe and reliable installation and operation of the product. Failure to install any Mr.Steam® product according to the applicable manual may result in property damage or an inoperable or hazardous condition. If you do not have the applicable Installation, Operation & Maintenance manual please contact Mr.Steam® for a free copy, or download a copy from www.mrsteam.com. If you have any questions about the installation, operation or maintenance of any Mr.Steam® product please contact a customer or technical service representative using the contact information on the back cover of this guide or consult a properly licensed contractor, architect and/or design professional.

TYPICAL MS GENERATOR



- 1 Contactor
- 2 Transformer
- 3 Liquid Level Control Board
- 4 Liquid Level Probe
- 5 Water Feed Solenoid
- 6 Heating Element
- 7 Express Steam Heater (optional)
- 8 Steam Outlet

- 9 Safety Valve
- 10 Drain Valve
- 11 Stainless Steel Tank
- 12 Water Inlet
- 13 Plug & Play Connection
- 14 Element Access Cover

For illustrative purposes only. Consult with a qualified designer, architect or contractor for steamroom construction details and proper product placement.

Product Dimensions*	Model No.	Total Room Volume (cu.ft.)	kW	Amps 240V/1PH	Wire Size AWG†	Water Usage Gallons**
 MS Generators 14 1/2" x 14 3/4" x 6 3/4"	MS90E	0 to 71	5	21	10	0.67
	MS150E	72-107	6	25	8	0.80
	MS225E	108-161	7.5	32	8	1.0
	MS400E	162-257	9	38	8	1.2
 SUPER Generators 17" x 18 1/2" x 7 7/8"	MSSUPER1E	258-339	10	42	8	1.4
	MSSUPER2E	340-411	12	50	6	1.6
	MSSUPER3E	412-482	15	63	4	2.0
NEW  MAX Generators 27 5/8" x 20 3/4" x 7 7/8"	MX4E	483-678	20	84	3	2.7
	MX5E	679-822	24	100	1	3.2
	MX6	823-964	30	125	2/0	4.0

* Dimensions are for generator only, without AutoFlush® or plumbing features.

† Wire size (AWG) based on minimum 90 rated THHN copper conductors. Refer to the National Electrical Code for other types of conductors.

** Water usage based on 20 minutes of operation.

**FOR ADDITIONAL INFORMATION ON
CONTROLS AND ACCESSORIES SEE
CORRESPONDING QUICK GUIDES**

⚠WARNING The information in this guide is designed to provide a general overview of how MrSteam® products are installed. All images and diagrams are for illustrative purposes only and may have been altered for presentation purposes. NEVER use this document for the Installation, Operation or Maintenance of any MrSteam® product. For installation, operation and maintenance information and instructions, only use the applicable MrSteam® Installation, Operation & Maintenance Manual(s). The specific Installation, Operation & Maintenance manual that is supplied with each MrSteam® product contains important information required for the safe and reliable installation and operation of the product. Failure to install any MrSteam® product according to the applicable manual may result in property damage or an inoperable or hazardous condition. If you do not have the applicable Installation, Operation & Maintenance manual please contact MrSteam® for a free copy, or download a copy from www.mrsteam.com. If you have any questions about the installation, operation or maintenance of any MrSteam® product please contact a customer or technical service representative using the contact information on the back cover of this guide or consult a properly licensed contractor, architect and/or design professional.



QUICK SET UP GUIDE

CONTROLS



For illustrative purposes only.

LOCATING THE iSTEAM® X, iTEMPO®, iTEMPO/PLUS® & AIRTEMPO® CONTROLS

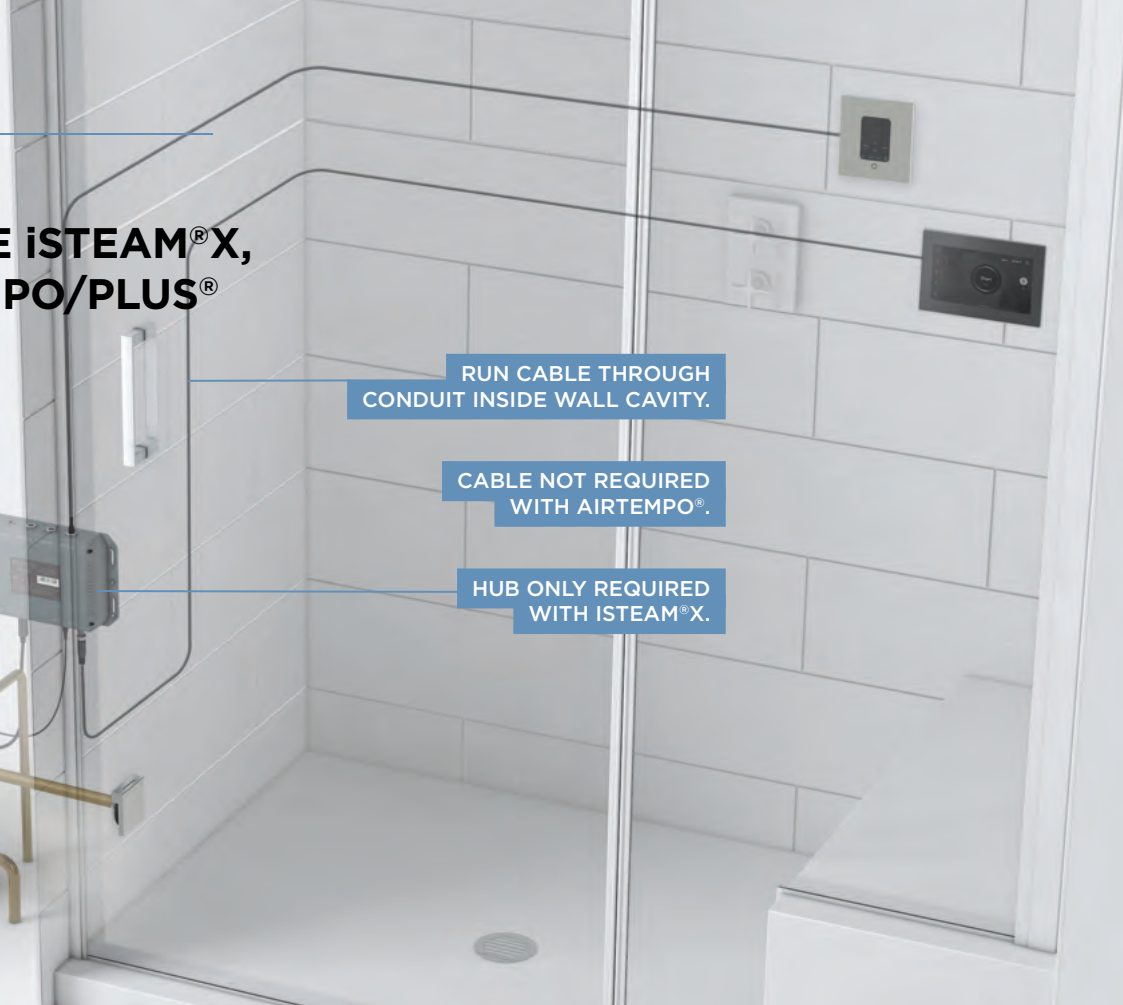
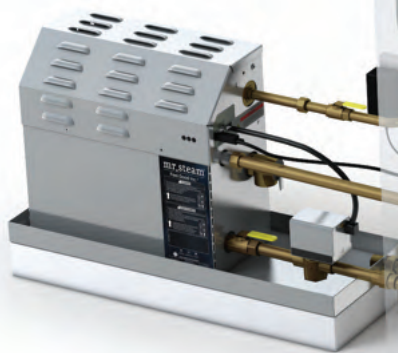

RUN CABLE THROUGH CONDUIT INSIDE WALL CAVITY.

CABLE NOT REQUIRED WITH AIRTEMPO®.

HUB ONLY REQUIRED WITH iSTEAM® X.

Locate control (or Remote Temperature Sensor) where it will sense general room temperature and NOT direct steam emission from the steam head.

Controls installed inside the steam room must be located 4-5 feet above the floor on a vertical wall.

Locating any control outside of the steam room will require the installation of a Remote Temperature Sensor inside the steam room (see page 13).

CAUTION: TO AVOID UNINTENTIONAL STEAM BATH OPERATION, DO NOT LOCATE THE CONTROL WHERE OTHER CONTROLS, ACCESSORIES, SHOWER HEADS, VALVES, BODY SPRAYS OR SIMILAR WITHIN THE SHOWER COULD CAUSE CONFUSION OR INTERFERE WITH THE MRSTEAM CONTROL'S INTENDED USE AND FUNCTION.



iSTEAM® X



iTEMPO/PLUS®



AIRTEMPO®

⚠️WARNING The information in this guide is designed to provide a general overview of how MrSteam® products are installed. All images and diagrams are for illustrative purposes only and may have been altered for presentation purposes. NEVER use this document for the Installation, Operation or Maintenance of any MrSteam® product. For installation, operation and maintenance information and instructions, only use the applicable MrSteam® Installation, Operation & Maintenance Manual(s). The specific Installation, Operation & Maintenance manual that is supplied with each MrSteam® product contains important information required for the safe and reliable installation and operation of the product. Failure to install any MrSteam® product according to the applicable manual may result in property damage, an inoperable system/control, or hazardous condition. If you do not have the applicable Installation, Operation & Maintenance manual please contact MrSteam® for a free copy, or download a copy from www.mrsteam.com. If you have any questions about the installation, operation or maintenance of any MrSteam® product please contact a customer or technical service representative using the contact information on the back cover of this guide or consult a properly licensed contractor, architect and/or design professional.

STEAMHEAD INSTALLATION LOCATION

IMPORTANT NOTE: To avoid unintentional steam bath operation, do not locate the control where other controls, accessories, shower heads, valves, body sprays or similar within the shower could cause confusion or interfere with the MrSteam control's intended use and function.



GOOD



BAD



**DO NOT LOCATE THE
CONTROL ABOVE OR NEAR
THE STEAM HEAD OR DIRECT
STEAM EMISSIONS**

⚠️WARNING The information in this guide is designed to provide a general overview of how MrSteam® products are installed. All images and diagrams are for illustrative purposes only and may have been altered for presentation purposes. NEVER use this document for the Installation, Operation or Maintenance of any MrSteam® product. For installation, operation and maintenance information and instructions, only use the applicable MrSteam® Installation, Operation & Maintenance Manual(s). The specific Installation, Operation & Maintenance manual that is supplied with each MrSteam® product contains important information required for the safe and reliable installation and operation of the product. Failure to install any MrSteam® product according to the applicable manual may result in property damage, an inoperable system/control, or hazardous condition. If you do not have the applicable Installation, Operation & Maintenance manual please contact MrSteam® for a free copy, or download a copy from www.mrsteam.com. If you have any questions about the installation, operation or maintenance of any MrSteam® product please contact a customer or technical service representative using the contact information on the back cover of this guide or consult a properly licensed contractor, architect and/or design professional.

iSTEAM® X CONTROL INSTALLATION

IMPORTANT NOTE: Turn power to the steam generator OFF before installing the control. Failure to turn the power off will result in an inoperable control.

STEP 1

PLUG the control cable into the steam generator (1A) and the iSteam®x hub (1B). Plug the iSteam®x cable into the iSteam®x hub (1B) and the iSteam®x (1C). Supply power to the iSteam®x hub and generator and test the control to verify proper function.

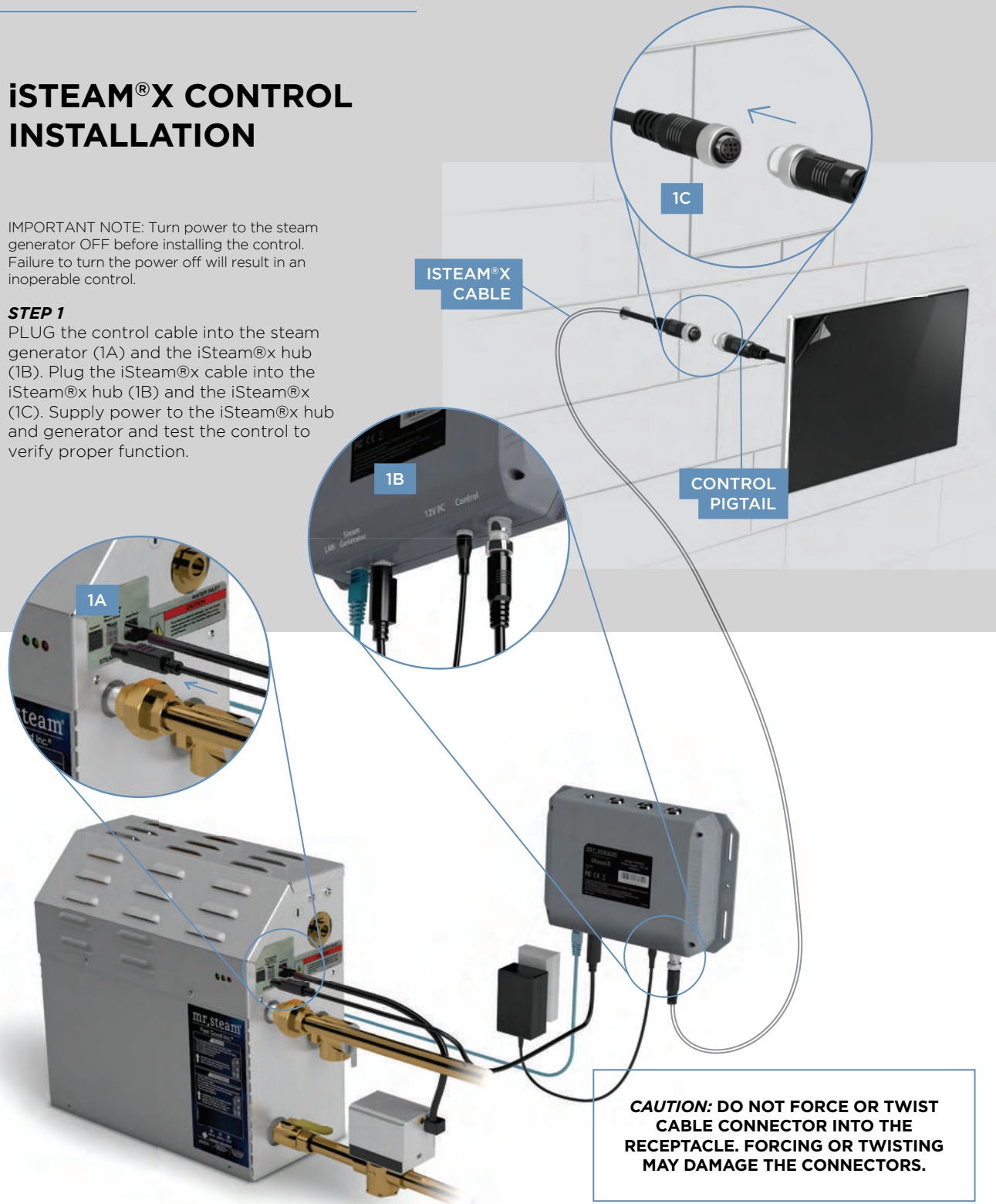

⚠️WARNING The information in this guide is designed to provide a general overview of how MrSteam® products are installed. All images and diagrams are for illustrative purposes only and may have been altered for presentation purposes. NEVER use this document for the Installation, Operation or Maintenance of any MrSteam® product. For installation, operation and maintenance information and instructions, only use the applicable MrSteam® Installation, Operation & Maintenance Manual(s). The specific Installation, Operation & Maintenance manual that is supplied with each MrSteam® product contains important information required for the safe and reliable installation and operation of the product. Failure to install any MrSteam® product according to the applicable manual may result in property damage, an inoperable system/control, or hazardous condition. If you do not have the applicable Installation, Operation & Maintenance manual please contact MrSteam® for a free copy, or download a copy from www.mrsteam.com. If you have any questions about the installation, operation or maintenance of any MrSteam® product please contact a customer or technical service representative using the contact information on the back cover of this guide or consult a properly licensed contractor, architect and/or design professional.

2A

**STEP 2**

Peel the adhesive film off the back of the iSteam control (2A). Apply a bead of silicone (provided) around the rear of the control as required to create a moisture seal (2B).

Ensure the control is level. Carefully feed the cable into the rough-in box and secure the control to the wall. Care must be taken to not pinch the cable.

2B

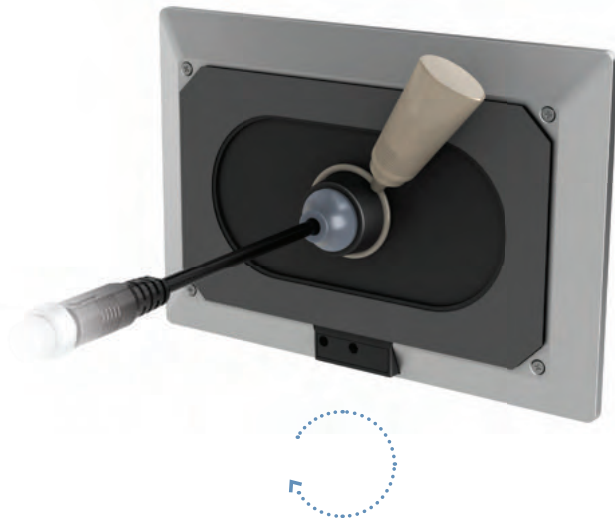

Remove and discard the peel off screen protector (2C).

2C



⚠️WARNING The information in this guide is designed to provide a general overview of how MrSteam® products are installed. All images and diagrams are for illustrative purposes only and may have been altered for presentation purposes. NEVER use this document for the Installation, Operation or Maintenance of any MrSteam® product. For installation, operation and maintenance information and instructions, only use the applicable MrSteam® Installation, Operation & Maintenance Manual(s). The specific Installation, Operation & Maintenance manual that is supplied with each MrSteam® product contains important information required for the safe and reliable installation and operation of the product. Failure to install any MrSteam® product according to the applicable manual may result in property damage, an inoperable system/control, or hazardous condition. If you do not have the applicable Installation, Operation & Maintenance manual please contact MrSteam® for a free copy, or download a copy from www.mrsteam.com. If you have any questions about the installation, operation or maintenance of any MrSteam® product please contact a customer or technical service representative using the contact information on the back cover of this guide or consult a properly licensed contractor, architect and/or design professional.

AIRTEMPO® SURFACE MOUNT INSTALLATION



A

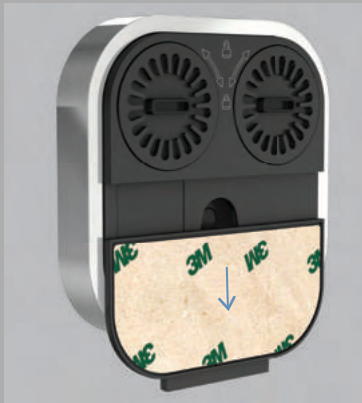

B



STEP 1

Determine the desired installation location of the control. The AirTempo controls are designed to be installed inside or outside the steam room as a matter of personal preference.

STEP 2

- Remove the surface mount bayonet from the back of the AirTempo Control (A).
- Remove and discard the release paper to expose the adhesive liner (B).

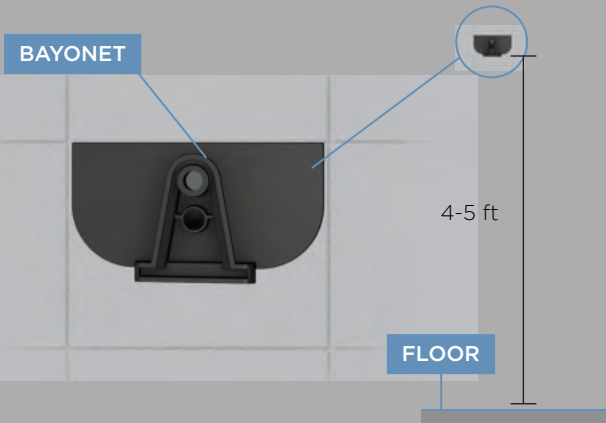

STEP 3

- Ensure the mounting surface is clean, flat/smooth, and dry.
- Place the bayonet on the wall in the desired location (on vertical wall 4-5 feet above the floor near the bather seating area).



STEP 4

- Wait 15 minutes before placing the control on the bayonet to ensure the adhesive is secured.

IMPORTANT NOTE: If the control is installed outside the steam room, a Remote Temperature Probe (part number MST5) must be installed inside the steam room. See Remote Temperature Sensor page 12.

Use the screw and anchor provided to secure the bayonet to the wall as required for rough or uneven wall surfaces. The surface mount bayonet supports the weight of the AirTempo® control.

⚠WARNING The information in this guide is designed to provide a general overview of how MrSteam® products are installed. All images and diagrams are for illustrative purposes only and may have been altered for presentation purposes. NEVER use this document for the Installation, Operation or Maintenance of any MrSteam® product. For installation, operation and maintenance information and instructions, only use the applicable MrSteam® Installation, Operation & Maintenance Manual(s). The specific Installation, Operation & Maintenance manual that is supplied with each MrSteam® product contains important information required for the safe and reliable installation and operation of the product. Failure to install any MrSteam® product according to the applicable manual may result in property damage, an inoperable system/control, or hazardous condition. If you do not have the applicable Installation, Operation & Maintenance manual please contact MrSteam® for a free copy, or download a copy from www.mrsteam.com. If you have any questions about the installation, operation or maintenance of any MrSteam® product please contact a customer or technical service representative using the contact information on the back cover of this guide or consult a properly licensed contractor, architect and/or design professional.

AIRTEMPO® WIRELESS RECEIVER INSTALLATION

The control can be located up to 60 feet from the wireless receiver. Construction materials may affect the communication between the control and the receiver. Test the range of the AirTempo®. It may be necessary to change the location of the wireless receiver to improve the range. Contact your local MrSteam® representative (<https://www.mrsteam.com/find-a-dealer>) for an optional 30 or 60 foot cable. Using the 3 foot cable provided, plug one end into the steam bath generator and the other end into the AirTempo® wireless receiver.



Attach the wireless receiver to a wall adjacent to the steam generator using the screw provided.

AIRTEMPO® FLUSH MOUNT INSTALLATION

STEP 1

Remove the surface mount bayonet from the back of the AirTempo® control. The surface mount bayonet is not used when flush mounting.

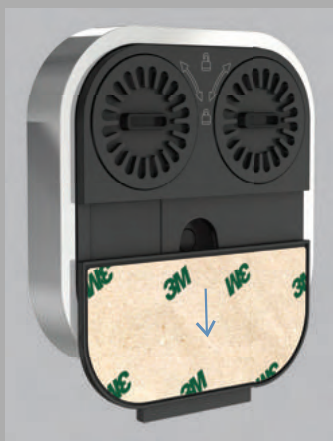

IMPORTANT NOTE: Flush mount components are sold separately (104232RD & 104232SQ). Contact a MrSteam® representative if a flush mount kit is needed.

⚠️WARNING The information in this guide is designed to provide a general overview of how MrSteam® products are installed. All images and diagrams are for illustrative purposes only and may have been altered for presentation purposes. NEVER use this document for the Installation, Operation or Maintenance of any MrSteam® product. For installation, operation and maintenance information and instructions, only use the applicable MrSteam® Installation, Operation & Maintenance Manual(s). The specific Installation, Operation & Maintenance manual that is supplied with each MrSteam® product contains important information required for the safe and reliable installation and operation of the product. Failure to install any MrSteam® product according to the applicable manual may result in property damage, an inoperable system/control, or hazardous condition. If you do not have the applicable Installation, Operation & Maintenance manual please contact MrSteam® for a free copy, or download a copy from www.mrsteam.com. If you have any questions about the installation, operation or maintenance of any MrSteam® product please contact a customer or technical service representative using the contact information on the back cover of this guide or consult a properly licensed contractor, architect and/or design professional.

**STEP 2**

Remove decorative bezel from AirTempo® control.

IMPORTANT NOTE: BE CAREFUL NOT TO DROP CONTROLLER WHEN RING POPS OFF

STEP 3

- Using the template provided, cut the hole in the desired location. Do not oversize or undersize the cutout. Ensure the template is level before cutting the hole.
- Test fit the flush mount box to ensure the hole is the correct size.
- Ensure the mounting surface is clean and dry.

STEP 4

Apply a bead of silicone (provided) around the rear of the control as required to create a moisture seal.

Remove and discard the release paper to expose the adhesive liner.

Press the flush mount box against the wall until the adhesive sticks and holds firmly.



⚠WARNING The information in this guide is designed to provide a general overview of how MrSteam® products are installed. All images and diagrams are for illustrative purposes only and may have been altered for presentation purposes. NEVER use this document for the Installation, Operation or Maintenance of any MrSteam® product. For installation, operation and maintenance information and instructions, only use the applicable MrSteam® Installation, Operation & Maintenance Manual(s). The specific Installation, Operation & Maintenance manual that is supplied with each MrSteam® product contains important information required for the safe and reliable installation and operation of the product. Failure to install any MrSteam® product according to the applicable manual may result in property damage, an inoperable system/control, or hazardous condition. If you do not have the applicable Installation, Operation & Maintenance manual please contact MrSteam® for a free copy, or download a copy from www.mrsteam.com. If you have any questions about the installation, operation or maintenance of any MrSteam® product please contact a customer or technical service representative using the contact information on the back cover of this guide or consult a properly licensed contractor, architect and/or design professional.

STEP 5

Place the electronic assembly into the decorative bezel as shown.

**STEP 6**

The retention ring snaps onto the assembly from behind. The 3 piece assembly can then be placed into the flush mount box.



⚠WARNING The information in this guide is designed to provide a general overview of how MrSteam® products are installed. All images and diagrams are for illustrative purposes only and may have been altered for presentation purposes. NEVER use this document for the Installation, Operation or Maintenance of any MrSteam® product. For installation, operation and maintenance information and instructions, only use the applicable MrSteam® Installation, Operation & Maintenance Manual(s). The specific Installation, Operation & Maintenance manual that is supplied with each MrSteam® product contains important information required for the safe and reliable installation and operation of the product. Failure to install any MrSteam® product according to the applicable manual may result in property damage, an inoperable system/control, or hazardous condition. If you do not have the applicable Installation, Operation & Maintenance manual please contact MrSteam® for a free copy, or download a copy from www.mrsteam.com. If you have any questions about the installation, operation or maintenance of any MrSteam® product please contact a customer or technical service representative using the contact information on the back cover of this guide or consult a properly licensed contractor, architect and/or design professional.

iTEMPO OR iTEMPO/PLUS CONTROL INSTALLATION

IMPORTANT NOTE: Turn power to the steam generator OFF before installing the control. Failure to turn the power off will result in an inoperable control.



STEP 1

Firmly connect the control cable to the control pigtail. Turn on power to the steam generator and test the control to verify correct connections. Test per instructions.

Disconnect control cable. Make a 2-5/8" wide by 3-7/8" high cutout in the desired control location.



STEP 2

Firmly connect control cable. Remove & discard peel-off paper to expose adhesive liner.

STEP 3

Apply a bead of silicone (provided) around the rear of the control as required to create a moisture seal.



STEP 4

Ensure the mounting surface is clean, flat/smooth, and dry as required for good adhesion. Hold the control with the LED display in the 12 o'clock position and press the control against the wall until the adhesive sticks and holds firmly as shown.

⚠WARNING The information in this guide is designed to provide a general overview of how MrSteam® products are installed. All images and diagrams are for illustrative purposes only and may have been altered for presentation purposes. NEVER use this document for the Installation, Operation or Maintenance of any MrSteam® product. For installation, operation and maintenance information and instructions, only use the applicable MrSteam® Installation, Operation & Maintenance Manual(s). The specific Installation, Operation & Maintenance manual that is supplied with each MrSteam® product contains important information required for the safe and reliable installation and operation of the product. Failure to install any MrSteam® product according to the applicable manual may result in property damage, an inoperable system/control, or hazardous condition. If you do not have the applicable Installation, Operation & Maintenance manual please contact MrSteam® for a free copy, or download a copy from www.mrsteam.com. If you have any questions about the installation, operation or maintenance of any MrSteam® product please contact a customer or technical service representative using the contact information on the back cover of this guide or consult a properly licensed contractor, architect and/or design professional.

REMOTE TEMPERATURE SENSOR (MSTS)

A Remote Temperature Sensor is required when the control is installed outside the steam room.

Locate the Remote Temperature Sensor where it will sense general room temperature and NOT direct steam emission from the steam head. Refer to the MrSteam Installation manual for additional control installation information.



For illustrative purposes only. Consult with qualified designer, architect or contractor for steamroom construction details.

4-5 ft

INSTALLING A REMOTE TEMPERATURE PROBE

STEP 1

The Probe must be installed:

- A. On a vertical surface
- B. 4-5 feet above the Floor
- C. In a location representative of the desired steambathing temperatures. Do not locate the probe above or near the steam head or direct steam emissions. The probe has an integral 30 or 60 ft. cable. Ensure that the probe and control are located accordingly.

STEP 2

Drill a 5/16 inch hole in the wall. Do not oversize or undersize the hole. Clean area thoroughly.

STEP 3

Route the end of the temperature probe cable with the temperature probe through a conduit inside the wall cavity as shown in Figure 1.

FIGURE 1

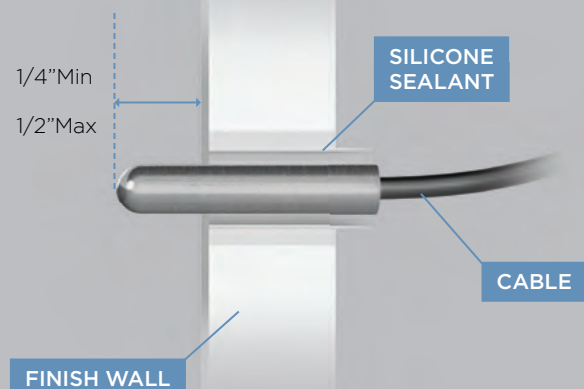

⚠️WARNING The information in this guide is designed to provide a general overview of how MrSteam® products are installed. All images and diagrams are for illustrative purposes only and may have been altered for presentation purposes. NEVER use this document for the Installation, Operation or Maintenance of any MrSteam® product. For installation, operation and maintenance information and instructions, only use the applicable MrSteam® Installation, Operation & Maintenance Manual(s). The specific Installation, Operation & Maintenance manual that is supplied with each MrSteam® product contains important information required for the safe and reliable installation and operation of the product. Failure to install any MrSteam® product according to the applicable manual may result in property damage, an inoperable system/control, or hazardous condition. If you do not have the applicable Installation, Operation & Maintenance manual please contact MrSteam® for a free copy, or download a copy from www.mrsteam.com. If you have any questions about the installation, operation or maintenance of any MrSteam® product please contact a customer or technical service representative using the contact information on the back cover of this guide or consult a properly licensed contractor, architect and/or design professional.

STEP 4

With a minimal length of the cable exposed, apply silicone (provided) to the hole in the wall as required to create a moisture seal as shown in Figure 2.

FIGURE 2

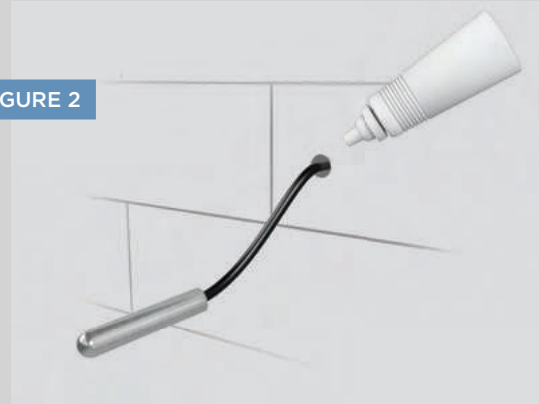

STEP 5

Push the Remote Temperature Probe into hole as required to leave between 1/4"- 1/2" of the probe. Exposed as shown in Figure 3.

FIGURE 3

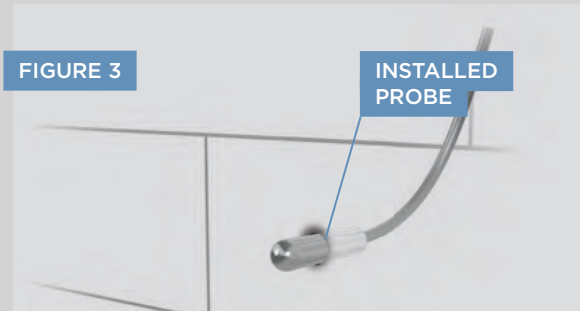

STEP 6

Ensure a minimum of 1/4" of the probe is exposed to the air. Failure to do so may result in an inoperative control and a hazardous condition. The exposed area of the probe must be free of silicone or any materials that prevent direct exposure to the steam room air. Failure to do so may interfere with the ability to sense temperature and may result in excessive steam room temperatures.

IMPORTANT NOTE: DO NOT STRAIN, STAPLE, PINCH OR OTHERWISE DAMAGE THE PROBE CABLE.

STEP 7

Plug MSTs into location shown on PC board (EXT. TEMP)

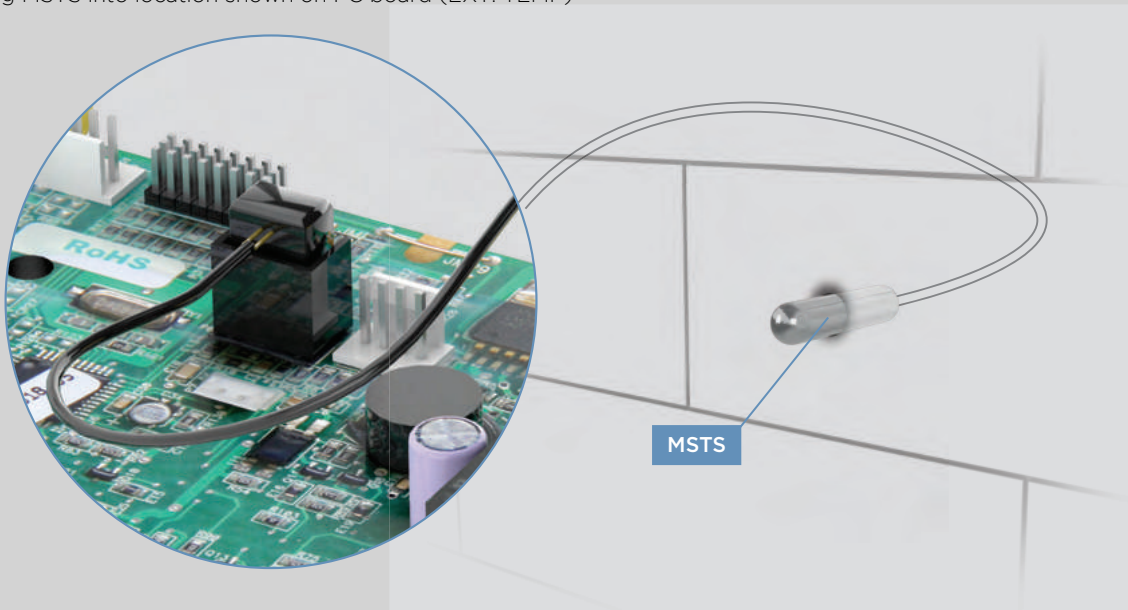

⚠️WARNING The information in this guide is designed to provide a general overview of how MrSteam® products are installed. All images and diagrams are for illustrative purposes only and may have been altered for presentation purposes. NEVER use this document for the Installation, Operation or Maintenance of any MrSteam® product. For installation, operation and maintenance information and instructions, only use the applicable MrSteam® Installation, Operation & Maintenance Manual(s). The specific Installation, Operation & Maintenance manual that is supplied with each MrSteam® product contains important information required for the safe and reliable installation and operation of the product. Failure to install any MrSteam® product according to the applicable manual may result in property damage, an inoperable system/control, or hazardous condition. If you do not have the applicable Installation, Operation & Maintenance manual please contact MrSteam® for a free copy, or download a copy from www.mrsteam.com. If you have any questions about the installation, operation or maintenance of any MrSteam® product please contact a customer or technical service representative using the contact information on the back cover of this guide or consult a properly licensed contractor, architect and/or design professional.

CONNECTING THE CONTROL CABLE TO THE STEAM GENERATOR

Route the control cable (provided with the control) from the wall cutout to the steam generator. When installing iTempo or iTempo Plus route the control cable (provided with the control) from the wall cut out to the steam generator. If installing an iSteamX the control cable is routed from the iSteam®X Hub to the steam generator and the iSteam®X control cable get routed from the wall cut out to the iSteam®X Hub.

The 30' (and optional 60') control cable features identical Mini-Din connectors at both ends.

IMPORTANT NOTE: The standard length of the cable for connecting the control to the steam generator is 30 feet. The steam generator and control must be located accordingly. Contact a MrSteam® representative (<https://www.mrsteam.com/find-a-dealer>) to purchase an optional 60 ft. cable (PN 103990-60) for iTempo® controls. A 60 foot cable is available for use with iSteam®x controls (PN 104117-60).



For illustrative purposes only. Consult with qualified designer, architect or contractor for steam room construction details.

IMPORTANT NOTE: The standard length of the cable for connecting the control to the steam generator is 30 feet.

IMPORTANT NOTE: DO NOT STRAIN, STAPLE, PINCH OR OTHERWISE DAMAGE THE CONTROL CABLE. ROUTE CABLE AS REQUIRED TO PERMIT REPLACEMENT.

⚠️WARNING The information in this guide is designed to provide a general overview of how MrSteam® products are installed. All images and diagrams are for illustrative purposes only and may have been altered for presentation purposes. NEVER use this document for the Installation, Operation or Maintenance of any MrSteam® product. For installation, operation and maintenance information and instructions, only use the applicable MrSteam® Installation, Operation & Maintenance Manual(s). The specific Installation, Operation & Maintenance manual that is supplied with each MrSteam® product contains important information required for the safe and reliable installation and operation of the product. Failure to install any MrSteam® product according to the applicable manual may result in property damage, an inoperable system/control, or hazardous condition. If you do not have the applicable Installation, Operation & Maintenance manual please contact MrSteam® for a free copy, or download a copy from www.mrsteam.com. If you have any questions about the installation, operation or maintenance of any MrSteam® product please contact a customer or technical service representative using the contact information on the back cover of this guide or consult a properly licensed contractor, architect and/or design professional.

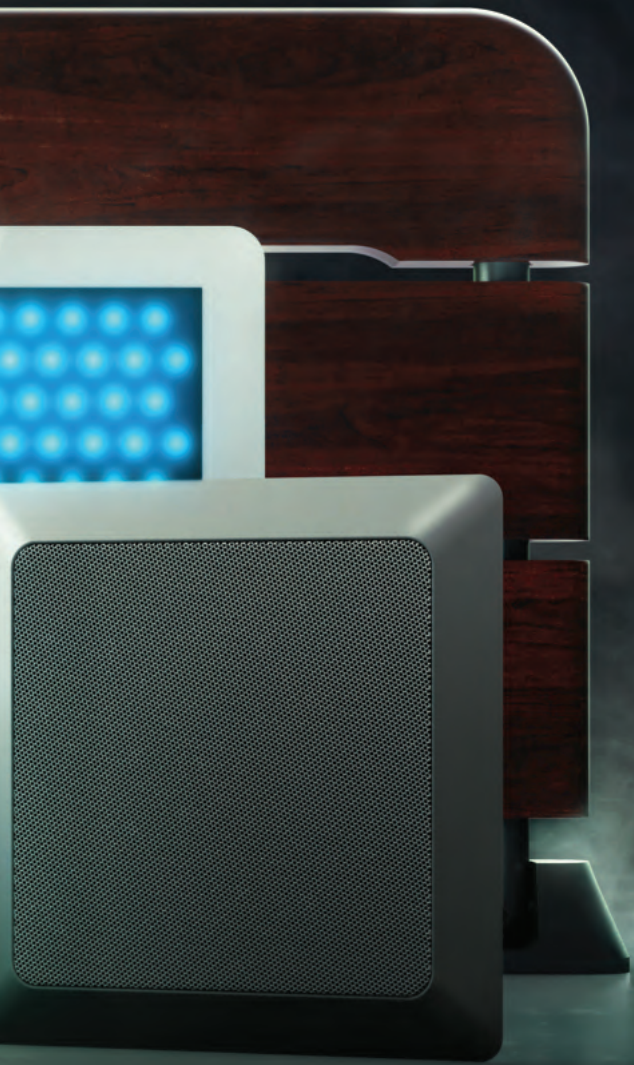

QUICK SET UP GUIDE
ACCESSORIES



For illustrative purposes only.

AROMASTEAM SYSTEM

Electronic Oil delivery system evenly infuses aroma into steam for an aromatherapy experience. Complete with oil container caddy, hoses, fittings and oil check valve.

AromaSteam Essential oils are available in one-liter bottles. Not for use with acrylic or fiberglass rooms.

DO NOT EXCEED 30 FEET OF TUBING OR A VERTICAL DISTANCE OF 6 FEET BETWEEN THE PUMP HEAD AND CHECK VALVE.



STEP 1

Install the AromaSteam in a location convenient for replacing essential oil bottles.

STEP 2

Install the Check valve into a tee in the steamline.

STEP 3

Connect the preassembled pressure tube to the AromaSteam pump and the check valve.

STEP 4

Connect the preassembled suction tube to the AromaSteam pump and place the end into the essential oil bottle. Place the essential oil bottle into the caddy provided.

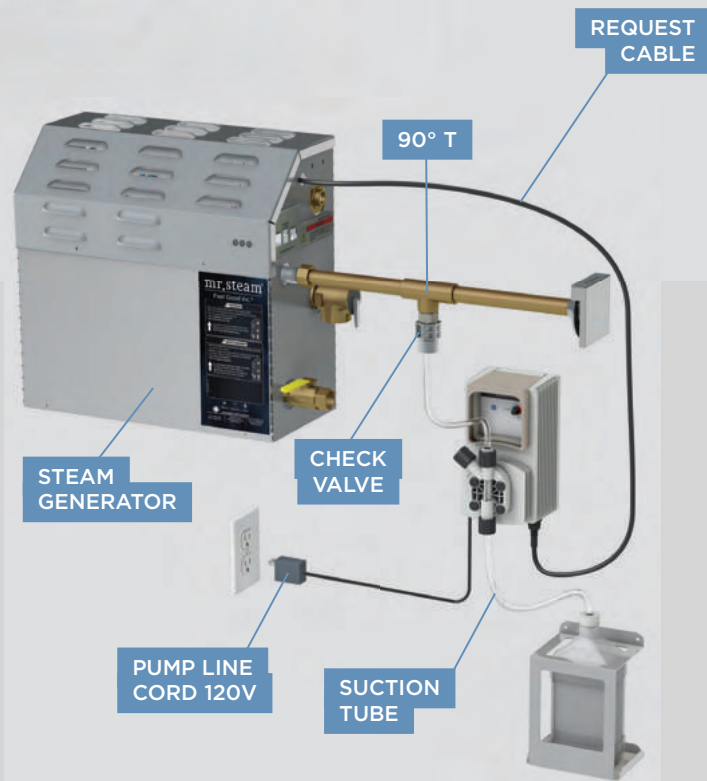

⚠️WARNING The information in this guide is designed to provide a general overview of how MrSteam® products are installed. All images and diagrams are for illustrative purposes only and may have been altered for presentation purposes. NEVER use this document for the Installation, Operation or Maintenance of any MrSteam® product. For installation, operation and maintenance information and instructions, only use the applicable MrSteam® Installation, Operation & Maintenance Manual(s). The specific Installation, Operation & Maintenance manual that is supplied with each MrSteam® product contains important information required for the safe and reliable installation and operation of the product. Failure to install any MrSteam® product according to the applicable manual may result in property damage, an inoperable system/control, or hazardous condition. If you do not have the applicable Installation, Operation & Maintenance manual please contact MrSteam® for a free copy, or download a copy from www.mrsteam.com. If you have any questions about the installation, operation or maintenance of any MrSteam® product please contact a customer or technical service representative using the contact information on the back cover of this guide or consult a properly licensed contractor, architect and/or design professional.

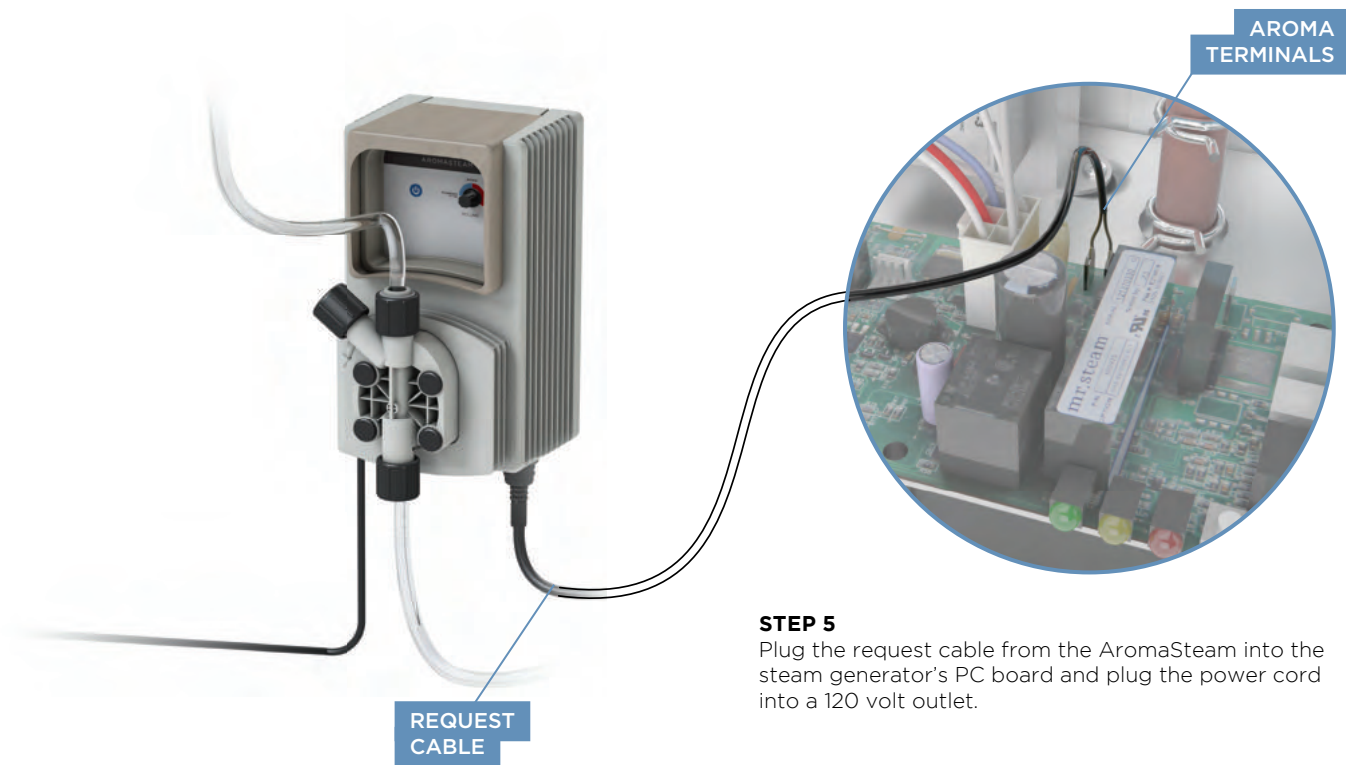

⚠WARNING The information in this guide is designed to provide a general overview of how MrSteam® products are installed. All images and diagrams are for illustrative purposes only and may have been altered for presentation purposes. NEVER use this document for the Installation, Operation or Maintenance of any MrSteam® product. For installation, operation and maintenance information and instructions, only use the applicable MrSteam® Installation, Operation & Maintenance Manual(s). The specific Installation, Operation & Maintenance manual that is supplied with each MrSteam® product contains important information required for the safe and reliable installation and operation of the product. Failure to install any MrSteam® product according to the applicable manual may result in property damage, an inoperable system/control, or hazardous condition. If you do not have the applicable Installation, Operation & Maintenance manual please contact MrSteam® for a free copy, or download a copy from www.mrsteam.com. If you have any questions about the installation, operation or maintenance of any MrSteam® product please contact a customer or technical service representative using the contact information on the back cover of this guide or consult a properly licensed contractor, architect and/or design professional.

AROMASTEAM STEAMHEAD

NOTE: Steamhead to be installed 6-12" above the finished floor. A 1.5" diameter hole in the steam room is required to mount the steamhead. Refer to the MrSteam Installation Manual for additional installation information.

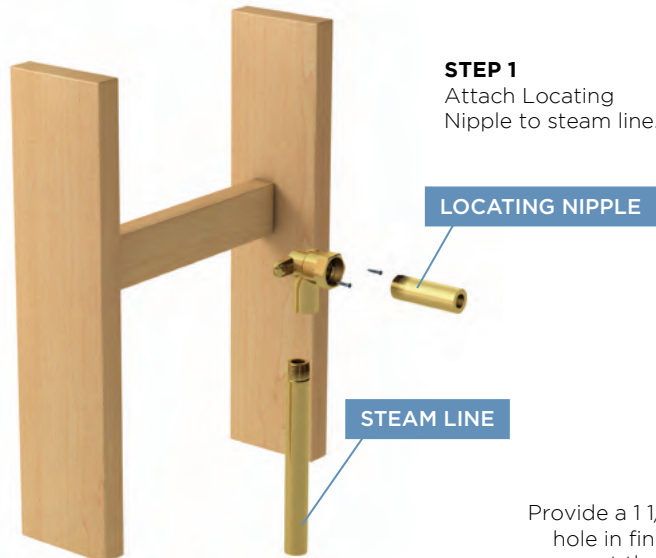

STEP 2
Provide a 1 1/2" diameter hole in finished wall to mount the steamhead.



The Acrylic Shield (PN 103938 for round and 103938SQ for square) is for use when acrylic or other non-heat resistant materials are used for the steamroom enclosure. The Acrylic Shield is to be installed between the finished wall and the steamhead.

NOTE: Do not locate the control above or near the SteamHead

⚠️WARNING The information in this guide is designed to provide a general overview of how MrSteam® products are installed. All images and diagrams are for illustrative purposes only and may have been altered for presentation purposes. NEVER use this document for the Installation, Operation or Maintenance of any MrSteam® product. For installation, operation and maintenance information and instructions, only use the applicable MrSteam® Installation, Operation & Maintenance Manual(s). The specific Installation, Operation & Maintenance manual that is supplied with each MrSteam® product contains important information required for the safe and reliable installation and operation of the product. Failure to install any MrSteam® product according to the applicable manual may result in property damage, an inoperable system/control, or hazardous condition. If you do not have the applicable Installation, Operation & Maintenance manual please contact MrSteam® for a free copy, or download a copy from www.mrsteam.com. If you have any questions about the installation, operation or maintenance of any MrSteam® product please contact a customer or technical service representative using the contact information on the back cover of this guide or consult a properly licensed contractor, architect and/or design professional.



USING ESSENTIAL OILS WITH THE AROMASTEAM™ STEAMHEAD

- Enjoy essential oils by placing a drop or two, into your steamhead as shown in the illustration.
- Tightly close containers when storing oils.
- Keep away from sources of ignition.

For illustrative purposes only. Consult with qualified designer, architect or contractor for steamroom construction details.

⚠WARNING

1. START WITH ONE DROP TO GAUGE STRENGTH AND SUITABILITY. LIMIT TO A MAXIMUM OF A FEW DROPS DURING A STEAMBATHING SESSION.

2. PLACE THE DROPS INTO THE MRSTEAM AROMASTEAM STEAMHEAD WELL PRIOR TO TURNING ON THE STEAMBATH. DO NOT PLACE DROPS IN A HOT STEAM HEAD AS SERIOUS INJURY CAN RESULT IF YOU DO NOT FOLLOW THIS WARNING.

3. SOME PEOPLE MAY FIND THAT THE AROMA MAKES THEM DIZZY AND THE USER SHOULD EXIT THE STEAM BATH IMMEDIATELY. IF SKIN IRRITATION OCCURS STOP USING THE OILS IMMEDIATELY. REMOVE ANY EXCESS OIL BY WASHING IN MILD

SOAP AND WATER. IF INGESTED, RINSE MOUTH WITH WATER. ADMINISTER WATER OR MILK TO DILUTE. CONTACT A PHYSICIAN IMMEDIATELY.

4. USE ESSENTIAL OILS WITH CAUTION. ESSENTIAL OILS ARE FOR EXTERNAL USE ONLY. KEEP OUT OF REACH OF CHILDREN. ESSENTIAL OILS ARE HIGHLY CONCENTRATED AND ARE POTENT SUBSTANCES AND SHOULD NOT BE APPLIED DIRECTLY TO THE SKIN AS THEY CAN BE IRRITANTS. USE ESSENTIAL OILS WITH CAUTION.

5. ESSENTIAL OILS AND/OR AROMATHERAPY CAN CAUSE INFLAMMATION, BURNS, HEADACHE, NAUSEA AND ALLERGIC REACTIONS. CONSULT A PHYSICIAN BEFORE USING AROMATHERAPY.

⚠WARNING The information in this guide is designed to provide a general overview of how MrSteam® products are installed. All images and diagrams are for illustrative purposes only and may have been altered for presentation purposes. NEVER use this document for the Installation, Operation or Maintenance of any MrSteam® product. For installation, operation and maintenance information and instructions, only use the applicable MrSteam® Installation, Operation & Maintenance Manual(s). The specific Installation, Operation & Maintenance manual that is supplied with each MrSteam® product contains important information required for the safe and reliable installation and operation of the product. Failure to install any MrSteam® product according to the applicable manual may result in property damage, an inoperable system/control, or hazardous condition. If you do not have the applicable Installation, Operation & Maintenance manual please contact MrSteam® for a free copy, or download a copy from www.mrsteam.com. If you have any questions about the installation, operation or maintenance of any MrSteam® product please contact a customer or technical service representative using the contact information on the back cover of this guide or consult a properly licensed contractor, architect and/or design professional.

LINEAR STEAMHEAD



Do not locate the steam head in any location where the steam emission zone is near a seat, bench, or any space occupied by any persons. For a diagram of the steam emission zone.

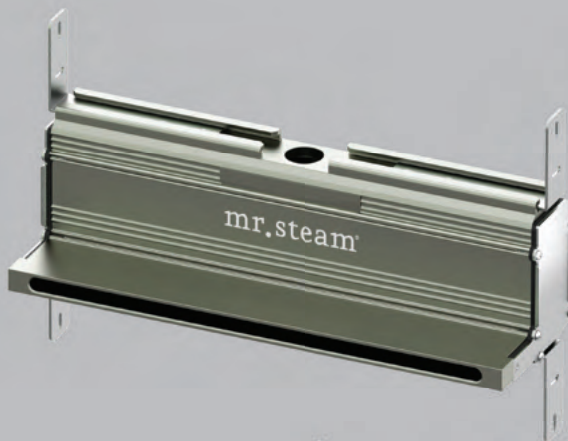

The brackets can slide horizontally (Figure 1).



FIGURE 1

For illustrative purposes only. Consult with qualified designer, architect or contractor for steamroom construction details.

⚠️WARNING The information in this guide is designed to provide a general overview of how MrSteam® products are installed. All images and diagrams are for illustrative purposes only and may have been altered for presentation purposes. NEVER use this document for the Installation, Operation or Maintenance of any MrSteam® product. For installation, operation and maintenance information and instructions, only use the applicable MrSteam® Installation, Operation & Maintenance Manual(s). The specific Installation, Operation & Maintenance manual that is supplied with each MrSteam® product contains important information required for the safe and reliable installation and operation of the product. Failure to install any MrSteam® product according to the applicable manual may result in property damage, an inoperable system/control, or hazardous condition. If you do not have the applicable Installation, Operation & Maintenance manual please contact MrSteam® for a free copy, or download a copy from www.mrsteam.com. If you have any questions about the installation, operation or maintenance of any MrSteam® product please contact a customer or technical service representative using the contact information on the back cover of this guide or consult a properly licensed contractor, architect and/or design professional.

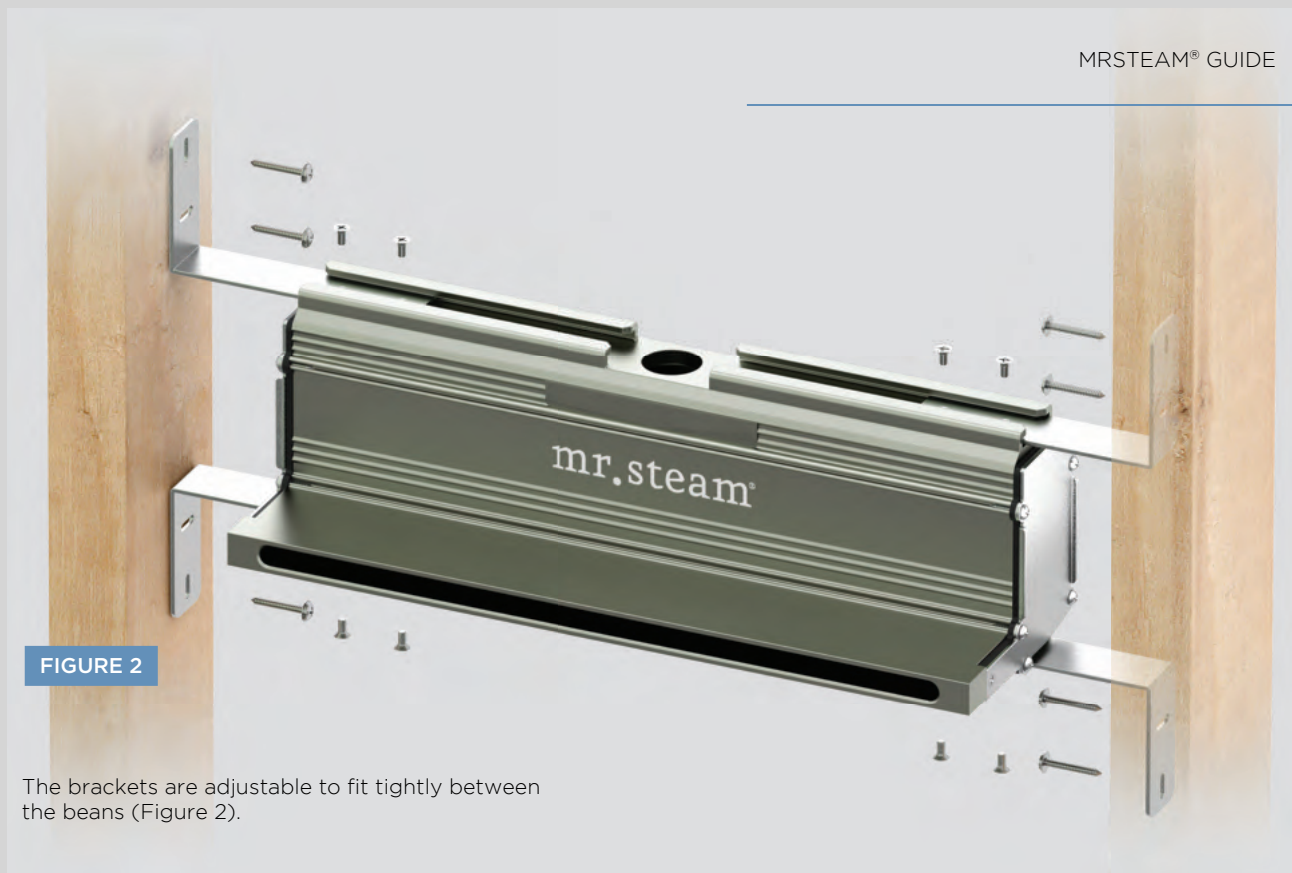
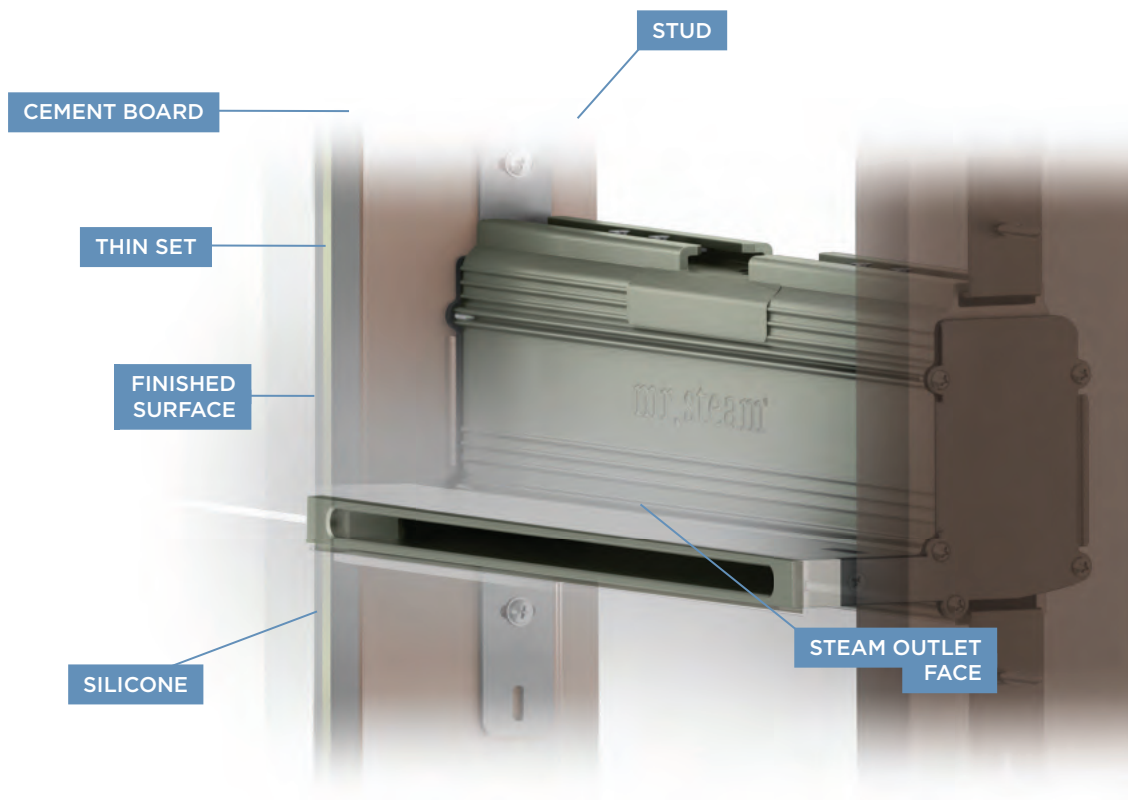
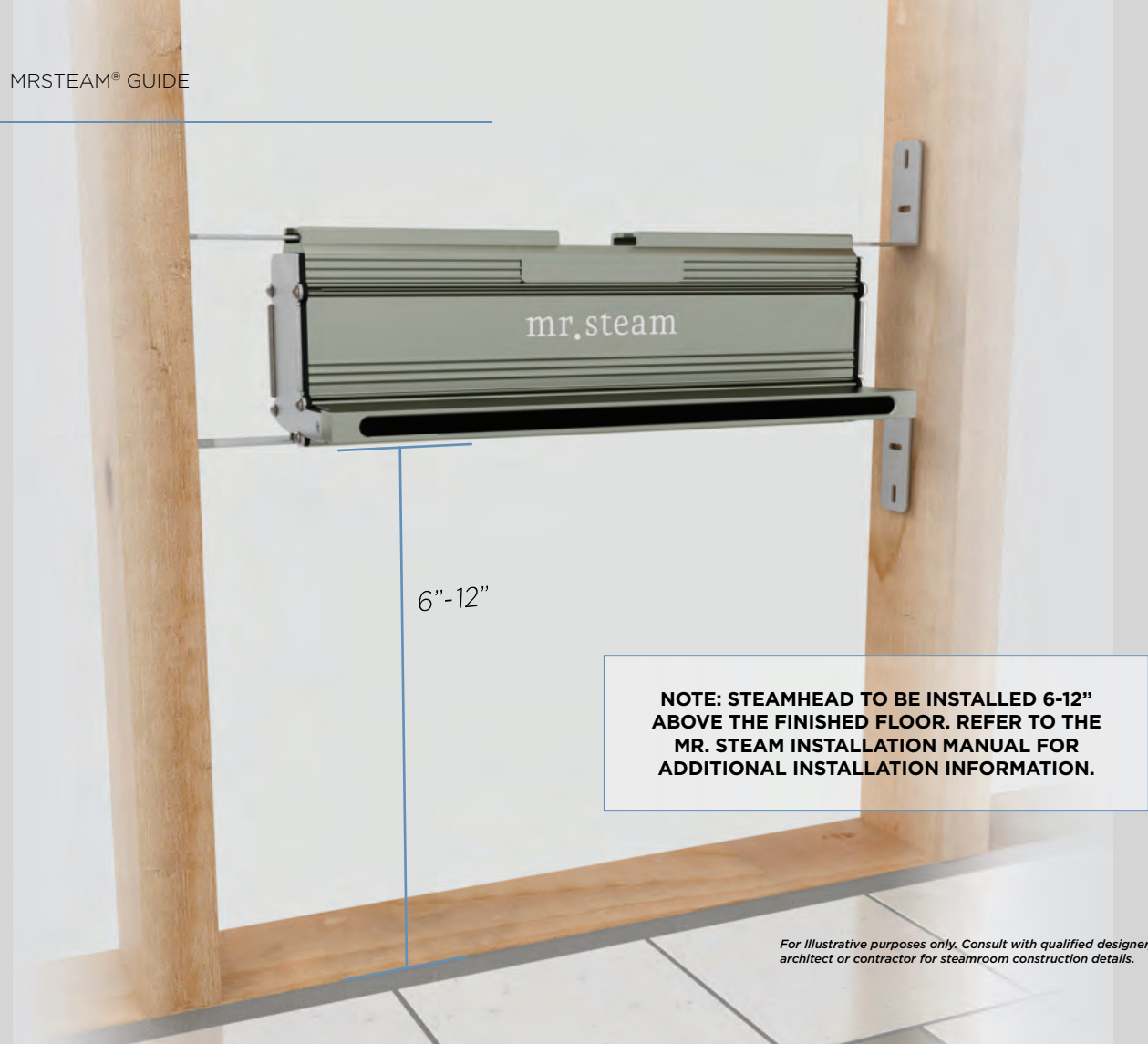

FIGURE 2

The brackets are adjustable to fit tightly between the beans (Figure 2).



⚠️WARNING The information in this guide is designed to provide a general overview of how MrSteam® products are installed. All images and diagrams are for illustrative purposes only and may have been altered for presentation purposes. NEVER use this document for the Installation, Operation or Maintenance of any MrSteam® product. For installation, operation and maintenance information and instructions, only use the applicable MrSteam® Installation, Operation & Maintenance Manual(s). The specific Installation, Operation & Maintenance manual that is supplied with each MrSteam® product contains important information required for the safe and reliable installation and operation of the product. Failure to install any MrSteam® product according to the applicable manual may result in property damage, an inoperable system/control, or hazardous condition. If you do not have the applicable Installation, Operation & Maintenance manual please contact MrSteam® for a free copy, or download a copy from www.mrsteam.com. If you have any questions about the installation, operation or maintenance of any MrSteam® product please contact a customer or technical service representative using the contact information on the back cover of this guide or consult a properly licensed contractor, architect and/or design professional.



NOTE: STEAMHEAD TO BE INSTALLED 6-12" ABOVE THE FINISHED FLOOR. REFER TO THE MR. STEAM INSTALLATION MANUAL FOR ADDITIONAL INSTALLATION INFORMATION.

For illustrative purposes only. Consult with qualified designer, architect or contractor for steamroom construction details.

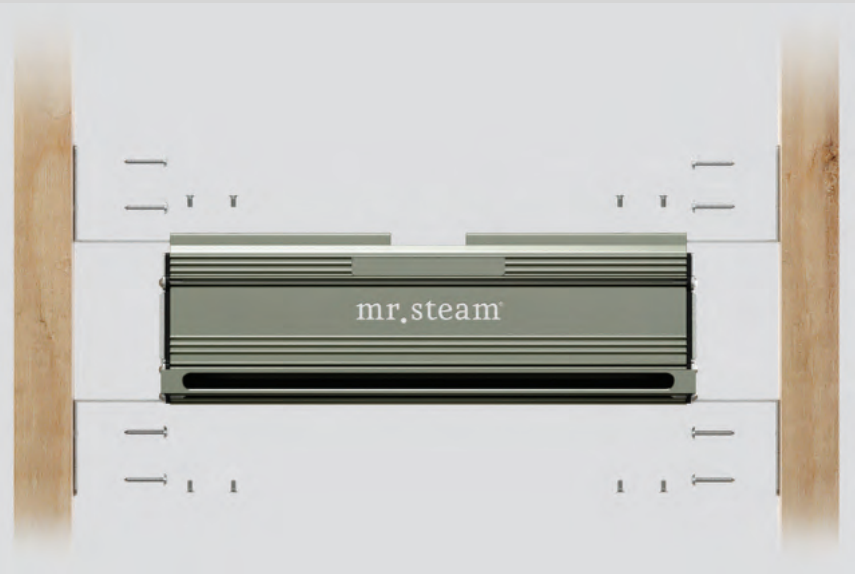

STEP 1
 Determine the location of the finished wall surface. Mount the steam head between two studs by screws through the four slotted holes. Use a level to ensure steam head is level in both the horizontal and vertical positions. Position the steam head face to be flush or extend 1/8" from the finished wall surface. 3/4" NPT Steam line opening should be on top. DO NOT mount steam head upside down. Tighten the 8 screws on the 4 brackets to secure the steamhead in the correct location between the studs.

⚠️WARNING The information in this guide is designed to provide a general overview of how MrSteam® products are installed. All images and diagrams are for illustrative purposes only and may have been altered for presentation purposes. NEVER use this document for the Installation, Operation or Maintenance of any MrSteam® product. For installation, operation and maintenance information and instructions, only use the applicable MrSteam® Installation, Operation & Maintenance Manual(s). The specific Installation, Operation & Maintenance manual that is supplied with each MrSteam® product contains important information required for the safe and reliable installation and operation of the product. Failure to install any MrSteam® product according to the applicable manual may result in property damage, an inoperable system/control, or hazardous condition. If you do not have the applicable Installation, Operation & Maintenance manual please contact MrSteam® for a free copy, or download a copy from www.mrsteam.com. If you have any questions about the installation, operation or maintenance of any MrSteam® product please contact a customer or technical service representative using the contact information on the back cover of this guide or consult a properly licensed contractor, architect and/or design professional.

STEP 2

Attach steam piping to the 3/4" NPT opening on the top of the linear steam head.

**STEP 3**

After the finished wall surface has been installed use high temperature caulking around the steam outlet as required to make a water proof seal.

For illustrative purposes only. Consult with qualified designer, architect or contractor for steamroom construction details.

⚠WARNING The information in this guide is designed to provide a general overview of how MrSteam® products are installed. All images and diagrams are for illustrative purposes only and may have been altered for presentation purposes. NEVER use this document for the Installation, Operation or Maintenance of any MrSteam® product. For installation, operation and maintenance information and instructions, only use the applicable MrSteam® Installation, Operation & Maintenance Manual(s). The specific Installation, Operation & Maintenance manual that is supplied with each MrSteam® product contains important information required for the safe and reliable installation and operation of the product. Failure to install any MrSteam® product according to the applicable manual may result in property damage, an inoperable system/control, or hazardous condition. If you do not have the applicable Installation, Operation & Maintenance manual please contact MrSteam® for a free copy, or download a copy from www.mrsteam.com. If you have any questions about the installation, operation or maintenance of any MrSteam® product please contact a customer or technical service representative using the contact information on the back cover of this guide or consult a properly licensed contractor, architect and/or design professional.

FACEPLATE

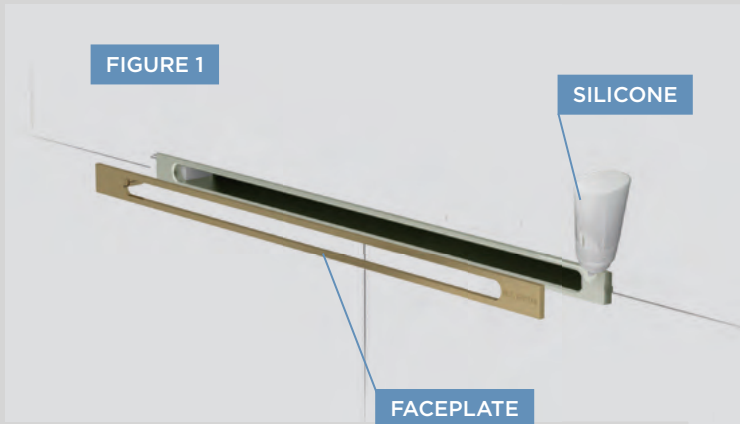

STEP 1

Securely press Faceplate into the opening of Linear Steam Head (Figure 1).

STEP 2

Apply silicone (supplied) in gap between the steam head and the tile as required to create a moisture seal. Failure to create a moisture seal may result in a leak within the wall cavity and cause problems associated with leaks, moisture and property damage from leaks (Figure 2).

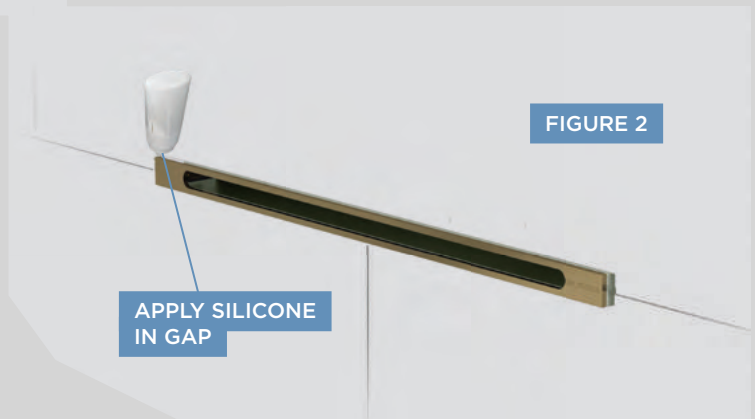

DIVERTER

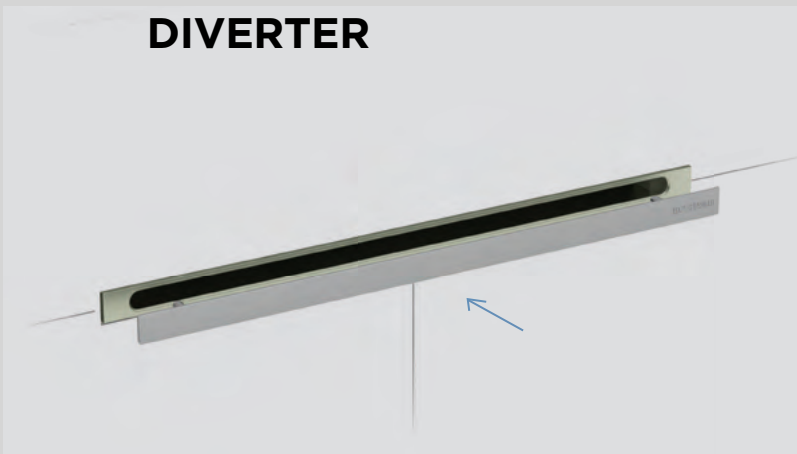

For illustrative purposes only. Consult with qualified designer, architect or contractor for steamroom construction details.

STEP 1

Never install, remove or adjust a diverter into the linear steam head when the steam head is hot or if steam is turned on. Installing, removing or adjusting a diverter into the linear steam head when the steam head is hot or if steam is turned on may cause a burn hazard and personal injury.

NOTE: BECAUSE DIRECT STEAM EMISSION IS VERY HOT, DIVERTER WILL BECOME HOT DURING STEAM SESSION, AND WILL REMAIN HOT FOR A PERIOD OF TIME AFTER STEAM SESSION.

⚠️WARNING The information in this guide is designed to provide a general overview of how MrSteam® products are installed. All images and diagrams are for illustrative purposes only and may have been altered for presentation purposes. NEVER use this document for the Installation, Operation or Maintenance of any MrSteam® product. For installation, operation and maintenance information and instructions, only use the applicable MrSteam® Installation, Operation & Maintenance Manual(s). The specific Installation, Operation & Maintenance manual that is supplied with each MrSteam® product contains important information required for the safe and reliable installation and operation of the product. Failure to install any MrSteam® product according to the applicable manual may result in property damage, an inoperable system/control, or hazardous condition. If you do not have the applicable Installation, Operation & Maintenance manual please contact MrSteam® for a free copy, or download a copy from www.mrsteam.com. If you have any questions about the installation, operation or maintenance of any MrSteam® product please contact a customer or technical service representative using the contact information on the back cover of this guide or consult a properly licensed contractor, architect and/or design professional.

AROMATRAY



STEP 1

Place Aroma Tray in steam outlet of Linear Steam Head (Figure 1) or on Diverter. (Figure 2) Place a drop or two of AromaSteam™ essential oil in AromaTray.

FIGURE 1



ESSENTIAL OIL

RESERVOIR FOR ESSENTIAL OIL

FIGURE 2

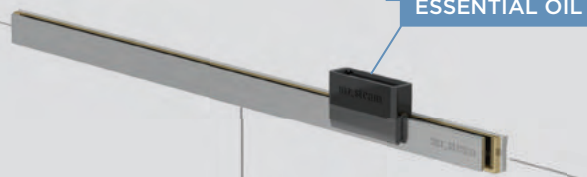

NOTE: THE AROMATRAY WILL BECOME HOT DURING A STEAM BATH SESSION, AND WILL REMAIN HOT FOR A PERIOD OF TIME AFTER THE STEAM BATH SESSION.

For illustrative purposes only. Consult with qualified designer, architect or contractor for steamroom construction details.

FACEPLATE

DIVERTER

AROMATRAY

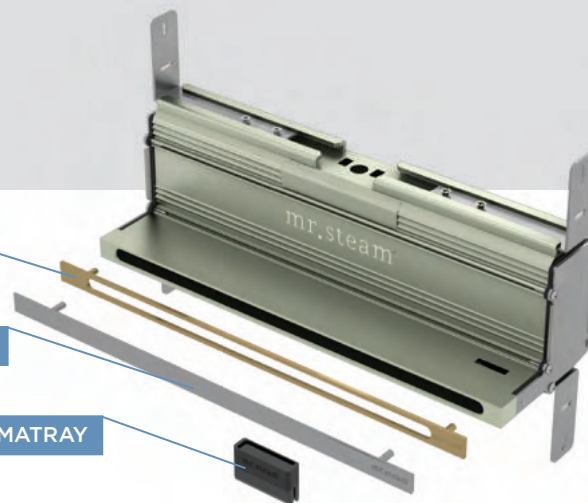

⚠WARNING The information in this guide is designed to provide a general overview of how MrSteam® products are installed. All images and diagrams are for illustrative purposes only and may have been altered for presentation purposes. NEVER use this document for the installation, operation or maintenance of any MrSteam® product. For installation, operation and maintenance information and instructions, only use the applicable MrSteam® Installation, Operation & Maintenance Manual(s). The specific Installation, Operation & Maintenance manual that is supplied with each MrSteam® product contains important information required for the safe and reliable installation and operation of the product. Failure to install any MrSteam® product according to the applicable manual may result in property damage, an inoperable system/control, or hazardous condition. If you do not have the applicable Installation, Operation & Maintenance manual please contact MrSteam® for a free copy, or download a copy from www.mrsteam.com. If you have any questions about the installation, operation or maintenance of any MrSteam® product please contact a customer or technical service representative using the contact information on the back cover of this guide or consult a properly licensed contractor, architect and/or design professional.

CHROMASTEAMX

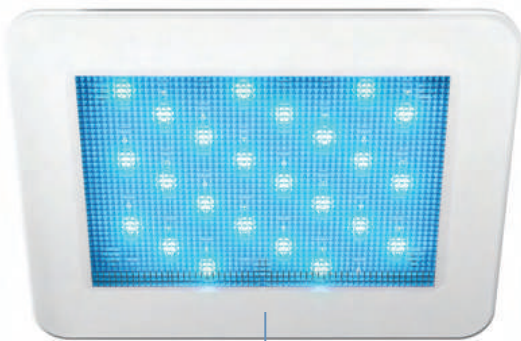

LED FIXTURE



CHROMA HUB

NOTE: FOR MOOD LIGHTING ONLY.

STEP 1

Locating the chroma hub. Determine the desired location of the ChromaSteamX control box outside the steam room in a dry location.

STEP 2

Installing the chroma hub. Using screws and washers, affix the chroma hub to a stable vertical surface (e.g., stud) using the mounting holes on either side of the chroma hub (Figure 1).

FIGURE 1



FIGURE 2

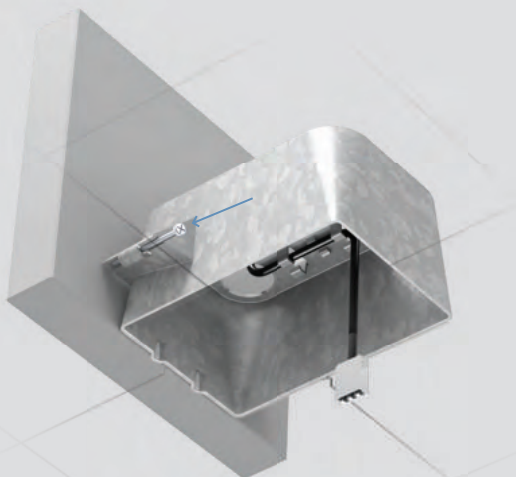

For illustrative purposes only. Consult with qualified designer, architect or contractor for steamroom construction details.

STEP 3

Install junction box. Remove one of the four knockouts from the junction box. The resulting hole will allow routing of the 30-foot LED power cable into the junction box. Locate the two tabs on the junction box, and line them up against a ceiling joist. The tabs locate the junction box proud of (slightly raised from) the joist. Screw the two screws into the ceiling joist to secure the junction box (Figure 2).

⚠️WARNING The information in this guide is designed to provide a general overview of how MrSteam® products are installed. All images and diagrams are for illustrative purposes only and may have been altered for presentation purposes. NEVER use this document for the Installation, Operation or Maintenance of any MrSteam® product. For installation, operation and maintenance information and instructions, only use the applicable MrSteam® Installation, Operation & Maintenance Manual(s). The specific Installation, Operation & Maintenance manual that is supplied with each MrSteam® product contains important information required for the safe and reliable installation and operation of the product. Failure to install any MrSteam® product according to the applicable manual may result in property damage, an inoperable system/control, or hazardous condition. If you do not have the applicable Installation, Operation & Maintenance manual please contact MrSteam® for a free copy, or download a copy from www.mrsteam.com. If you have any questions about the installation, operation or maintenance of any MrSteam® product please contact a customer or technical service representative using the contact information on the back cover of this guide or consult a properly licensed contractor, architect and/or design professional.

STEP 4

Connect the ChromaSteamX fixture's pigtail to the 30-foot LED power cable in the junction box (Figure 3).

FIGURE 4

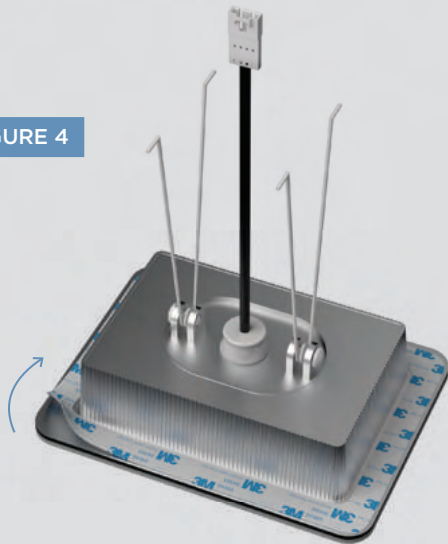
**STEP 5**

Squeeze the retention springs on the back of the fixture and fit them into the junction box (Figure 5). Insert the fixture into the junction box and affix it to the ceiling, being careful not to pinch the pigtail/LED power cable. Press firmly around edges of the fixture to ensure adhesion to ceiling.

FIGURE 6

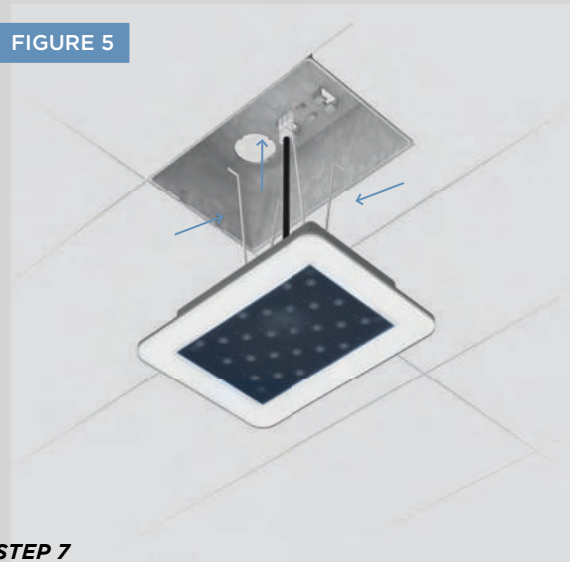

FIGURE 3

**STEP 5**

Clean the surface of the ceiling to ensure the double-stick adhesive of the fixture bonds completely to the ceiling. Peel off and discard the protective layer from the fixture's double-stick adhesive (Figure 4).

FIGURE 5

**STEP 7**

Apply a bead of silicone around the perimeter of the fixture (Figure 6) as required to create a moisture seal between the fixture and the steam room ceiling.

For illustrative purposes only. Consult with qualified designer, architect or contractor for steamroom construction details.

⚠WARNING The information in this guide is designed to provide a general overview of how MrSteam® products are installed. All images and diagrams are for illustrative purposes only and may have been altered for presentation purposes. NEVER use this document for the installation, operation or maintenance of any MrSteam® product. For installation, operation and maintenance information and instructions, only use the applicable MrSteam® Installation, Operation & Maintenance Manual(s). The specific Installation, Operation & Maintenance manual that is supplied with each MrSteam® product contains important information required for the safe and reliable installation and operation of the product. Failure to install any MrSteam® product according to the applicable manual may result in property damage, an inoperable system/control, or hazardous condition. If you do not have the applicable Installation, Operation & Maintenance manual please contact MrSteam® for a free copy, or download a copy from www.mrsteam.com. If you have any questions about the installation, operation or maintenance of any MrSteam® product please contact a customer or technical service representative using the contact information on the back cover of this guide or consult a properly licensed contractor, architect and/or design professional.

STEP 8

Plug the FREE END of the accessory communication cable into any of the accessory ports on the iSteam®x Hub (A in Figure 7).

STEP 9

Plug in the power supply provided with ChromaSteamX into the (B in Figure 7) ChromaSteamX control box port marked 12 VDC.

STEP 10

Plug the power supply into a standard outlet (C in Figure 7).

CAUTION: CHROMASTEAMX IS FOR MOOD LIGHTING ONLY, AND DOES NOT SUBSTITUTE FOR GENERAL SHOWER ILLUMINATION.

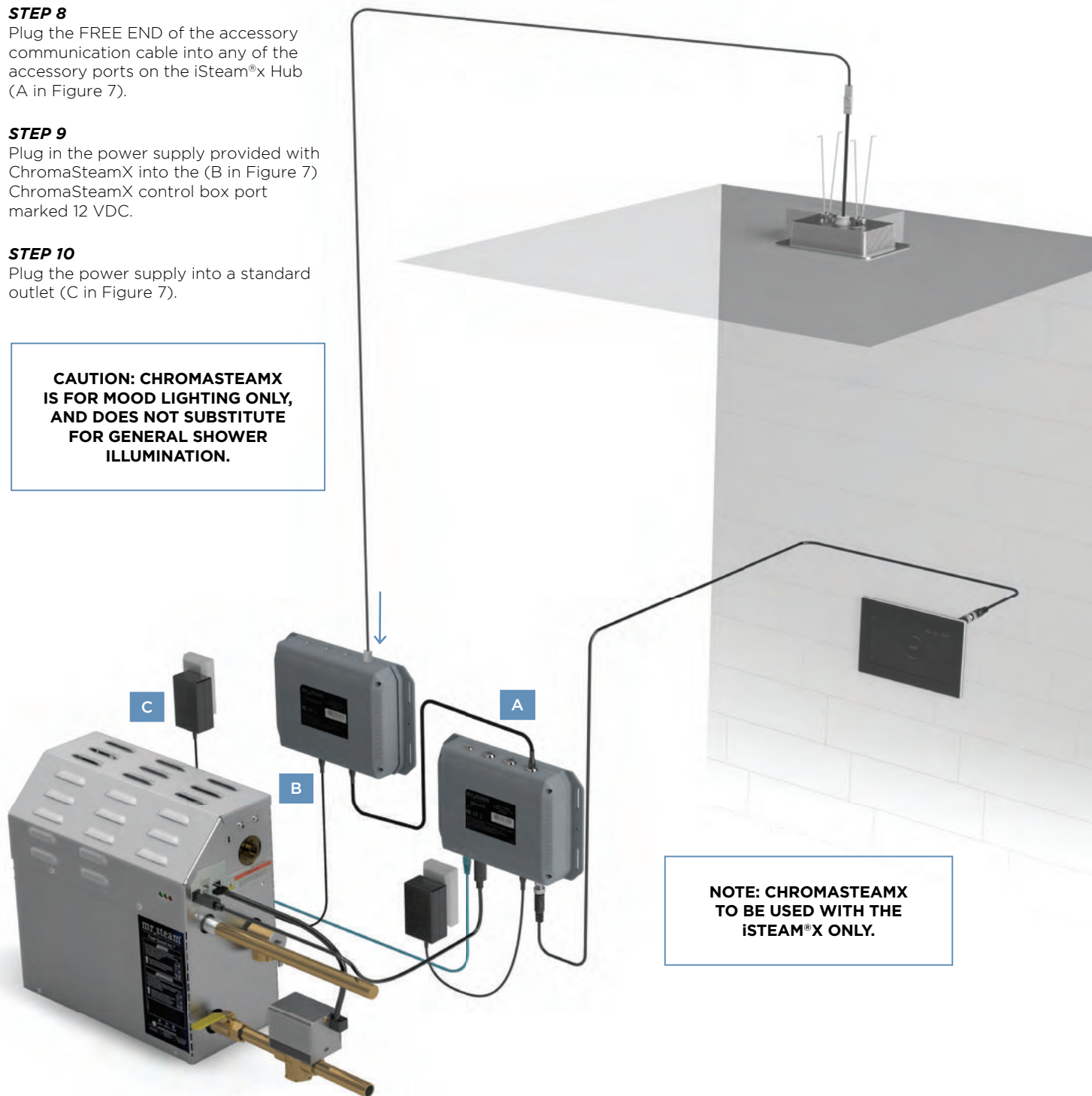

NOTE: CHROMASTEAMX TO BE USED WITH THE ISTEAM®X ONLY.

FIGURE 7

⚠WARNING The information in this guide is designed to provide a general overview of how MrSteam® products are installed. All images and diagrams are for illustrative purposes only and may have been altered for presentation purposes. NEVER use this document for the Installation, Operation or Maintenance of any MrSteam® product. For installation, operation and maintenance information and instructions, only use the applicable MrSteam® Installation, Operation & Maintenance Manual(s). The specific Installation, Operation & Maintenance manual that is supplied with each MrSteam® product contains important information required for the safe and reliable installation and operation of the product. Failure to install any MrSteam® product according to the applicable manual may result in property damage, an inoperable system/control, or hazardous condition. If you do not have the applicable Installation, Operation & Maintenance manual please contact MrSteam® for a free copy, or download a copy from www.mrsteam.com. If you have any questions about the installation, operation or maintenance of any MrSteam® product please contact a customer or technical service representative using the contact information on the back cover of this guide or consult a properly licensed contractor, architect and/or design professional.

CHROMASTEAM 72

STEP 1

Determine the placement of the light.

IMPORTANT: DO NOT INSTALL THE FIXTURE ASSEMBLY (LIGHT) WHERE DIRECT CONTACT WITH STEAM OR WATER EMISSION COULD OCCUR. DO NOT INSTALL THE LIGHT IN A LOCATION WHERE IT COULD BECOME SUBMERGED.

STEP 2

The light requires a 4 1/4" diameter hole for mounting.

STEP 3

Provide electrical service (120VAC) with flexible cable only. Pass cable through ceiling opening and wire fixture in accordance with NEC and local electrical code.

STEP 4

Route the 30 foot cable supplied with the Chroma Steam from your steam bath generator through one of the knockouts in the ChromaSteam light wiring box. Provide a suitable strain relief bushing.

IMPORTANT: The quick connect tabs should be on the generator side, the Molex connector should be routed to the light (Figure 2).

LIGHT FIXTURE

LED CLUSTER

STEP 5

Connect the quick connect tabs to the control board in the generator at the location marked CHROMA.

STEP 6

Remove the red jumper wire shown in Figure 1 and discard. Connect the wire from the steam generator to the connector where the jumper was.

STEP 7

Connect the supply wires. Use suitable wirenuts (not included) to insulate and secure the supply connections.

STEP 8

Connect copper ground wire from wiring box to ground wire from electrical service using a wire nut to secure the connection.

STEP 9

Insert the wired housing into the ceiling junction box first.

FIGURE 1

FIGURE 2

NOTE: FOR MOOD LIGHTING ONLY.

NOTE: CHROMASTEAM72 IS NOT FOR USE WITH THE iSTEAM®X CONTROL.

For illustrative purposes only. Consult with qualified designer, architect or contractor for steamroom construction details.

⚠WARNING The information in this guide is designed to provide a general overview of how MrSteam® products are installed. All images and diagrams are for illustrative purposes only and may have been altered for presentation purposes. NEVER use this document for the installation, operation or maintenance of any MrSteam® product. For installation, operation and maintenance information and instructions, only use the applicable MrSteam® Installation, Operation & Maintenance Manual(s). The specific Installation, Operation & Maintenance manual that is supplied with each MrSteam® product contains important information required for the safe and reliable installation and operation of the product. Failure to install any MrSteam® product according to the applicable manual may result in property damage, an inoperable system/control, or hazardous condition. If you do not have the applicable Installation, Operation & Maintenance manual please contact MrSteam® for a free copy, or download a copy from www.mrsteam.com. If you have any questions about the installation, operation or maintenance of any MrSteam® product please contact a customer or technical service representative using the contact information on the back cover of this guide or consult a properly licensed contractor, architect and/or design professional.

AUDIO@HOME

FIGURE 1



For illustrative purposes only. Consult with qualified designer, architect or contractor for steamroom construction details.

STEP 1

Locate Audio@Home to prevent water from getting inside the device, Audio@Home should be mounted on two stable vertical surfaces (e.g., studs) as shown in (Figure 1).

Using screws and washers, firmly attach Audio@Home using the upper mounting holes, one at a time, on each side of the unit. Repeat the process for the lower mounting holes (Figure 1).

STEP 2

Using a Phillips-head screwdriver, remove the two cover screws from the front of the Audio@Home and remove the cover from the unit. Connect the outputs of Audio@Home.

STEP 3

Connect 10-pin MATE-N-LOK adapter with attached wires — to the speaker outputs.

STEP 4

Plug the Audio@Home power cord into a 120V grounded electrical outlet.

⚠️WARNING The information in this guide is designed to provide a general overview of how MrSteam® products are installed. All images and diagrams are for illustrative purposes only and may have been altered for presentation purposes. NEVER use this document for the Installation, Operation or Maintenance of any MrSteam® product. For installation, operation and maintenance information and instructions, only use the applicable MrSteam® Installation, Operation & Maintenance Manual(s). The specific Installation, Operation & Maintenance manual that is supplied with each MrSteam® product contains important information required for the safe and reliable installation and operation of the product. Failure to install any MrSteam® product according to the applicable manual may result in property damage, an inoperable system/control, or hazardous condition. If you do not have the applicable Installation, Operation & Maintenance manual please contact MrSteam® for a free copy, or download a copy from www.mrsteam.com. If you have any questions about the installation, operation or maintenance of any MrSteam® product please contact a customer or technical service representative using the contact information on the back cover of this guide or consult a properly licensed contractor, architect and/or design professional.

MS-SPEAKER

- Two flush-mount two-way speakers for steam/shower use, polypropylene cones, ABS frames with grills.
- Suitable for almost any source of audio input.
- Rated 60W peak power 8 ohms impedance with 1" tweeter for full range sound.
- Use only CL2 or CL3 UL listed wires to connect speakers to audio source.
- Available in Round (6 1/2") and Square (7") in both white and black designs.



STEP 1

Determine the location of the speakers and cut the appropriate hole depending on speaker shape.

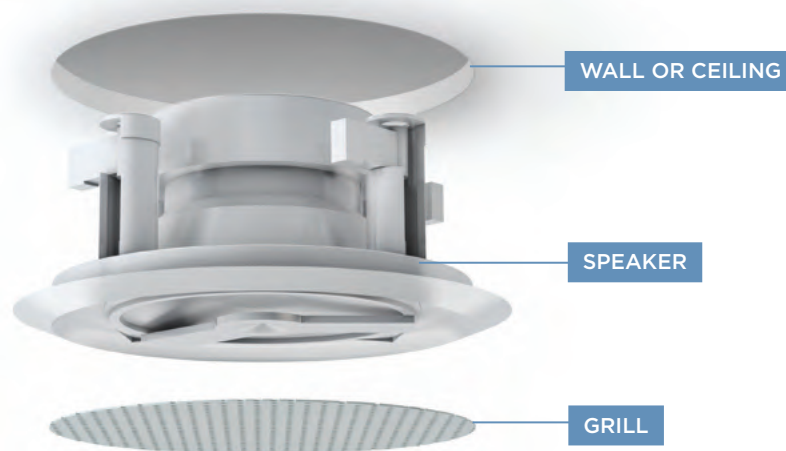

⚠WARNING The information in this guide is designed to provide a general overview of how MrSteam® products are installed. All images and diagrams are for illustrative purposes only and may have been altered for presentation purposes. NEVER use this document for the Installation, Operation or Maintenance of any MrSteam® product. For installation, operation and maintenance information and instructions, only use the applicable MrSteam® Installation, Operation & Maintenance Manual(s). The specific Installation, Operation & Maintenance manual that is supplied with each MrSteam® product contains important information required for the safe and reliable installation and operation of the product. Failure to install any MrSteam® product according to the applicable manual may result in property damage, an inoperable system/control, or hazardous condition. If you do not have the applicable Installation, Operation & Maintenance manual please contact MrSteam® for a free copy, or download a copy from www.mrsteam.com. If you have any questions about the installation, operation or maintenance of any MrSteam® product please contact a customer or technical service representative using the contact information on the back cover of this guide or consult a properly licensed contractor, architect and/or design professional.

STEP 2

Connect speaker wire



STEP 3

Apply a bead of silicone to the speaker flange.



STEP 4

Place the speaker in the hole and tighten the screws on the integral mounting bracket to secure the speaker.



⚠️WARNING The information in this guide is designed to provide a general overview of how MrSteam® products are installed. All images and diagrams are for illustrative purposes only and may have been altered for presentation purposes. NEVER use this document for the Installation, Operation or Maintenance of any MrSteam® product. For installation, operation and maintenance information and instructions, only use the applicable MrSteam® Installation, Operation & Maintenance Manual(s). The specific Installation, Operation & Maintenance manual that is supplied with each MrSteam® product contains important information required for the safe and reliable installation and operation of the product. Failure to install any MrSteam® product according to the applicable manual may result in property damage, an inoperable system/control, or hazardous condition. If you do not have the applicable Installation, Operation & Maintenance manual please contact MrSteam® for a free copy, or download a copy from www.mrsteam.com. If you have any questions about the installation, operation or maintenance of any MrSteam® product please contact a customer or technical service representative using the contact information on the back cover of this guide or consult a properly licensed contractor, architect and/or design professional.

SHOWER SEAT

STEP 1

Mount the WallSeat on a suitable surface like tile, granite or marble. Mount the seat at a height above the floor according to personal preference.

STEP 2

Using the template provided, drill four pilot holes into the header and 4 clearance holes into the tile. Use a level to ensure pilot holes are level. Be precise.

Do not oversize or undersize the pilot holes. Drill the pilot holes to the full 3" depth (length of the screws).

Fill the mounting holes with silicone (provided) before mounting the brackets to the wall as required to prevent moisture from penetrating into the wall and/or wall cavity.



FIGURE 1

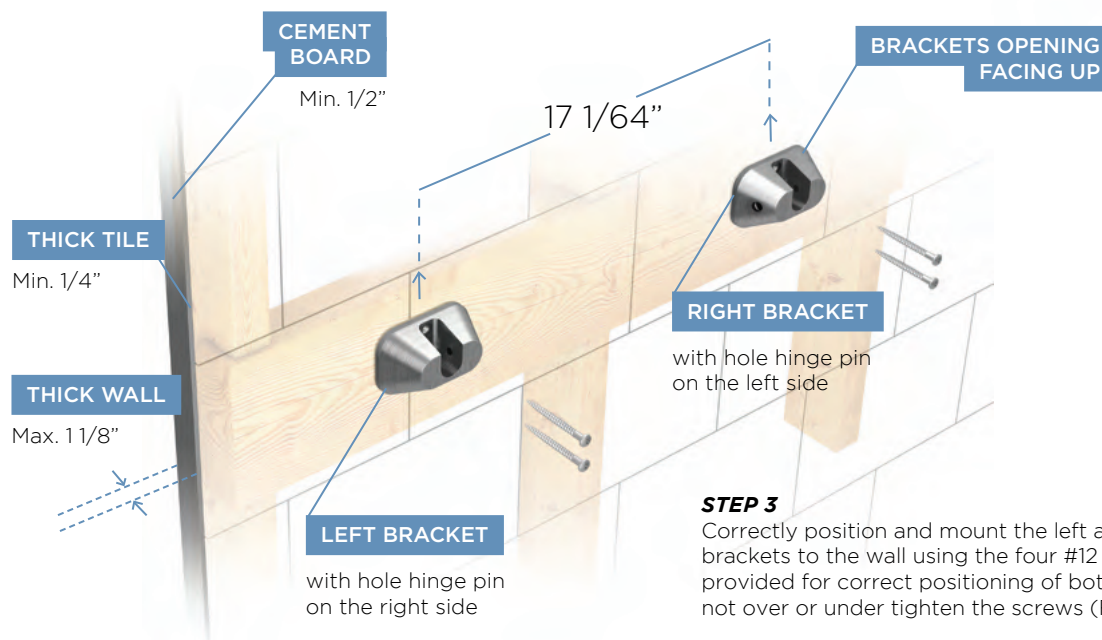

For illustrative purposes only. Consult with qualified designer, architect or contractor for steamroom construction details.

⚠WARNING The information in this guide is designed to provide a general overview of how MrSteam® products are installed. All images and diagrams are for illustrative purposes only and may have been altered for presentation purposes. NEVER use this document for the Installation, Operation or Maintenance of any MrSteam® product. For installation, operation and maintenance information and instructions, only use the applicable MrSteam® Installation, Operation & Maintenance Manual(s). The specific Installation, Operation & Maintenance manual that is supplied with each MrSteam® product contains important information required for the safe and reliable installation and operation of the product. Failure to install any MrSteam® product according to the applicable manual may result in property damage, an inoperable system/control, or hazardous condition. If you do not have the applicable Installation, Operation & Maintenance manual please contact MrSteam® for a free copy, or download a copy from www.mrsteam.com. If you have any questions about the installation, operation or maintenance of any MrSteam® product please contact a customer or technical service representative using the contact information on the back cover of this guide or consult a properly licensed contractor, architect and/or design professional.

FIGURE 2



STEP 4

Insert seat assembly to brackets. Place seat with the MrSteam logo on the bottom. Insert hinge pins to both left and right brackets while the seat assembly is in vertical position. Securely tighten both hinge pins, using Allen wrench provided (Figure 2).

FIGURE 3



LEVEL SCREW

STEP 5

If the seat is not parallel to the floor when it is in the lowered or seated position use the allen wrench provided to adjust both level screws so the wallseat is parallel to the floor and it contacts both brackets at the same time (Figure 3).

FIGURE 4



⚠️WARNING The information in this guide is designed to provide a general overview of how MrSteam® products are installed. All images and diagrams are for illustrative purposes only and may have been altered for presentation purposes. NEVER use this document for the Installation, Operation or Maintenance of any MrSteam® product. For installation, operation and maintenance information and instructions, only use the applicable MrSteam® Installation, Operation & Maintenance Manual(s). The specific Installation, Operation & Maintenance manual that is supplied with each MrSteam® product contains important information required for the safe and reliable installation and operation of the product. Failure to install any MrSteam® product according to the applicable manual may result in property damage, an inoperable system/control, or hazardous condition. If you do not have the applicable Installation, Operation & Maintenance manual please contact MrSteam® for a free copy, or download a copy from www.mrsteam.com. If you have any questions about the installation, operation or maintenance of any MrSteam® product please contact a customer or technical service representative using the contact information on the back cover of this guide or consult a properly licensed contractor, architect and/or design professional.



STEAMLINX® MODULE AND MOBILE APP



FIGURE 1

STEP 1

Disconnect power to the generator at the breaker box (Figure 1).

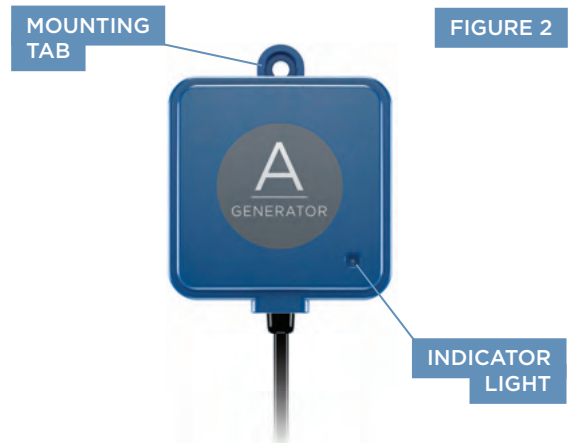

FIGURE 2

STEP 2

Locate SteamLinX A adjacent to the steam generator, mount to a secure surface using the mounting tab provided.

⚠WARNING The information in this guide is designed to provide a general overview of how MrSteam® products are installed. All images and diagrams are for illustrative purposes only and may have been altered for presentation purposes. NEVER use this document for the Installation, Operation or Maintenance of any MrSteam® product. For installation, operation and maintenance information and instructions, only use the applicable MrSteam® Installation, Operation & Maintenance Manual(s). The specific Installation, Operation & Maintenance manual that is supplied with each MrSteam® product contains important information required for the safe and reliable installation and operation of the product. Failure to install any MrSteam® product according to the applicable manual may result in property damage, an inoperable system/control, or hazardous condition. If you do not have the applicable Installation, Operation & Maintenance manual please contact MrSteam® for a free copy, or download a copy from www.mrsteam.com. If you have any questions about the installation, operation or maintenance of any MrSteam® product please contact a customer or technical service representative using the contact information on the back cover of this guide or consult a properly licensed contractor, architect and/or design professional.

STEP 3

Remove generator cover. Route the SteamLinx® A cable through the knockout (Figure 3).

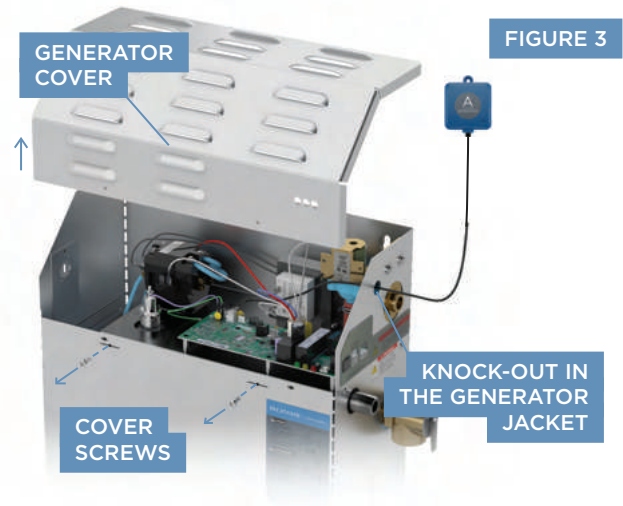

STEP 4

Plug the SteamLinx® A cable into one of the white connectors located at the far left side of the circuit board. Replace cover and screws.

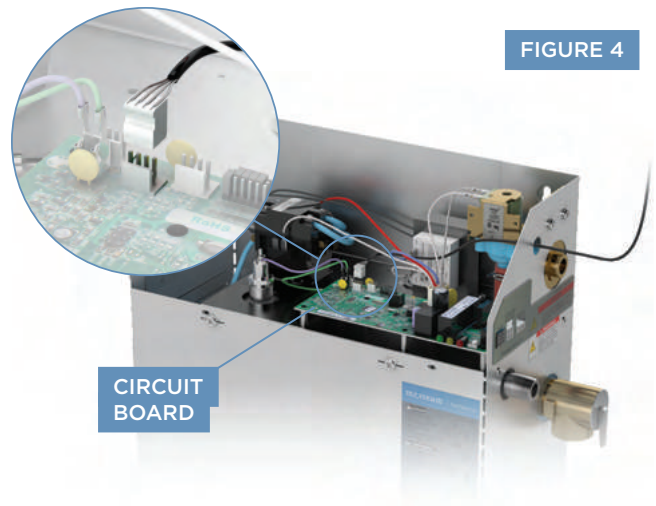

STEP 5

Plug the blue ethernet cable provided into an open ethernet port on the back of the router and the other end into SteamLinx® B. Plug the power supply into a 120V outlet (Figure 5).

STEP 6

Ensure the mobile device is connected to the router's WiFi network. Download the SteamLinx® App from the App Store or Google Play.

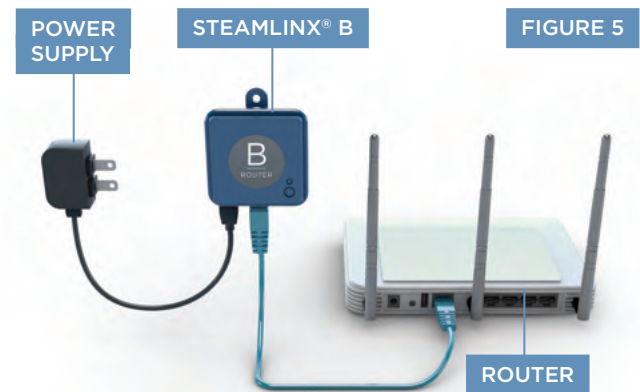

⚠️WARNING The information in this guide is designed to provide a general overview of how MrSteam® products are installed. All images and diagrams are for illustrative purposes only and may have been altered for presentation purposes. NEVER use this document for the Installation, Operation or Maintenance of any MrSteam® product. For installation, operation and maintenance information and instructions, only use the applicable MrSteam® Installation, Operation & Maintenance Manual(s). The specific Installation, Operation & Maintenance manual that is supplied with each MrSteam® product contains important information required for the safe and reliable installation and operation of the product. Failure to install any MrSteam® product according to the applicable manual may result in property damage, an inoperable system/control, or hazardous condition. If you do not have the applicable Installation, Operation & Maintenance manual please contact MrSteam® for a free copy, or download a copy from www.mrsteam.com. If you have any questions about the installation, operation or maintenance of any MrSteam® product please contact a customer or technical service representative using the contact information on the back cover of this guide or consult a properly licensed contractor, architect and/or design professional.

TYPICAL INSTALL OF DREAM PACKAGE SCHEMATIC

- | | | | |
|----------|------------------|----------|----------------------|
| 1 | Steamlinx® | 5 | SteamHead |
| 2 | Audio@Home | 6 | AromaSteam System |
| 3 | ChromaSteamx Hub | 7 | iSteam@x Control |
| 4 | iSteam@x Hub | 8 | Speakers |
| | | 9 | ChromaSteamX Fixture |

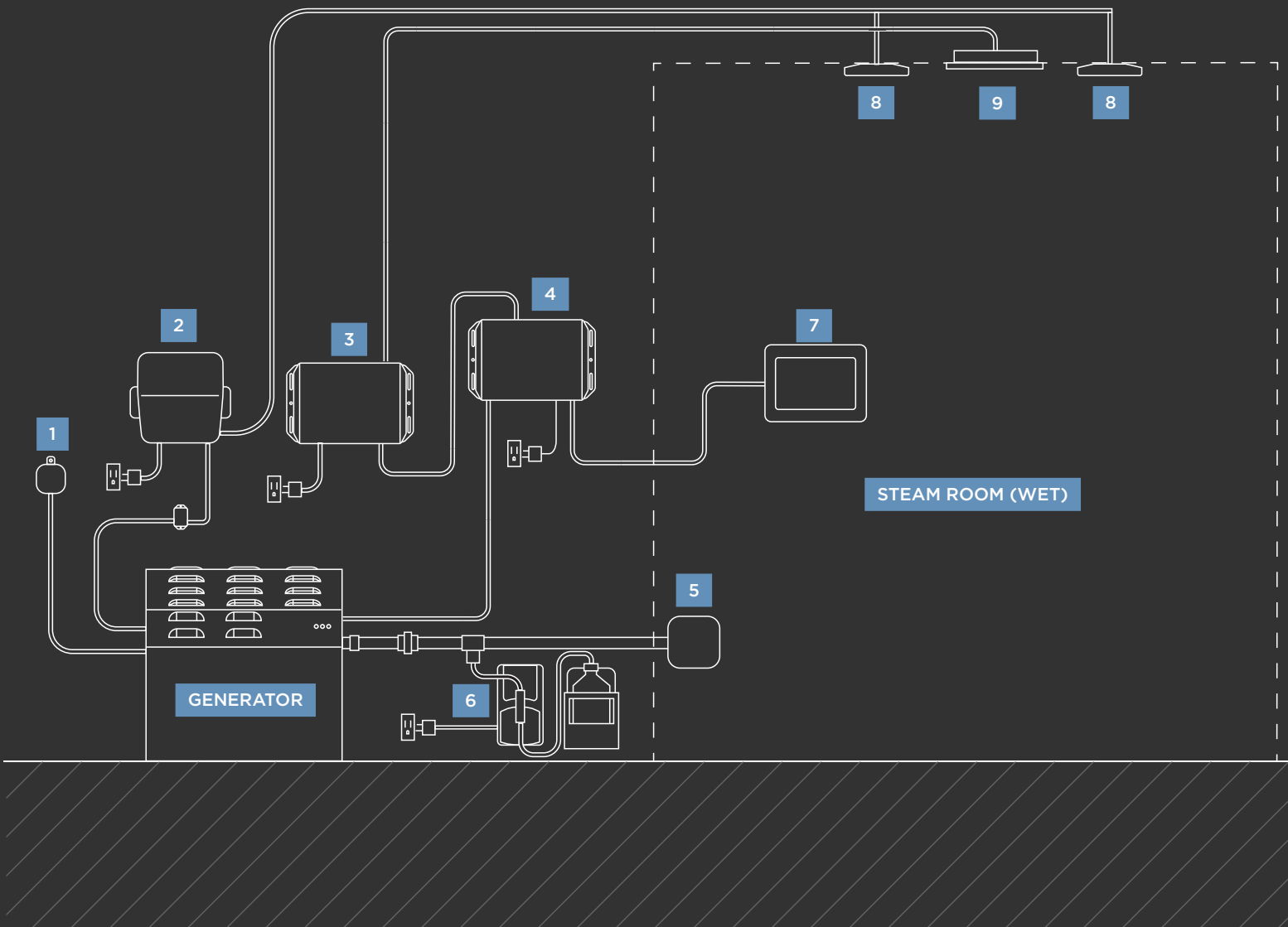

⚠️ WARNING The information in this guide is designed to provide a general overview of how MrSteam® products are installed. All images and diagrams are for illustrative purposes only and may have been altered for presentation purposes. NEVER use this document for the Installation, Operation or Maintenance of any MrSteam® product. For installation, operation and maintenance information and instructions, only use the applicable MrSteam® Installation, Operation & Maintenance Manual(s). The specific Installation, Operation & Maintenance manual that is supplied with each MrSteam® product contains important information required for the safe and reliable installation and operation of the product. Failure to install any MrSteam® product according to the applicable manual may result in property damage, an inoperable system/control, or hazardous condition. If you do not have the applicable Installation, Operation & Maintenance manual please contact MrSteam® for a free copy, or download a copy from www.mrsteam.com. If you have any questions about the installation, operation or maintenance of any MrSteam® product please contact a customer or technical service representative using the contact information on the back cover of this guide or consult a properly licensed contractor, architect and/or design professional.

A leader and innovator in residential and commercial steam shower systems, spa products and experiences.

CONTACT US

HEADQUARTERS
MrSteam Corporation®
43-20 34th Street
Long Island City, NY, 11101 USA
tel 1-800-76 STEAM (767-8326)

WEST COAST
MrSteam Corporation®
9410 South La Cienega Blvd
Los Angeles, CA, 90301 USA
tel 1-800-72 STEAM (727-8326)

Or write to us at hello@mrsteam.com

Mr. Steam, Mr. Steam and des., AirTempo, A Lifetime of Pleasure, AromaFlo, AutoFLUSH, Audio@Home, AutoSteam, Broadway Collection, Butler Package, ChromaSound Spa Package, ChromeSteamX, Clean Steam...Every Time, Club Therapy, Day Spa, Digital 1, Express Steam, Etempo, Etempo/Plus, Etempo/Start, Feel Good Inc., Fifth Avenue Collection, From Bathroom to Spa, HomeWizard, iButler, iDream Package, iGenie, iSpa Package, iSteamX, iTempo, iTempo/Plus, Linear, Linear Steamhead, Making Wellness a Way of Life, Metro Collection, Mrsauna, MusicTherapy, MySteam, Spa Package, Steam on Demand, Steam@Home, SmartSizing, Steam in a Box, SteamStart, SteamStop, SteamTherapy, Sussman, Tempo, Tala, The Intelligent Steam Bath, Virtual Spa System, and Warmatowel are registered trademarks of MrSteam Corporation.

HomeWizard is a trademark of MrSteam Corporation.

* Please refer to the applicable MrSteam Installation, Operation & Maintenance Manual, at mrsteam.com, for installation, operation and maintenance information and instructions. Failure to do so may result in property damage or an inoperable or hazardous condition. For safety and convenience, consult a qualified contractor, architect and/or design professional.

See product packaging and labeling for important information.

Copyright 2023 MrSteam Corporation. All rights reserved.

PUR100537, Revision 02/2023

mr.steam®



www.mrsteam.com