

Installation Support • Soporte de Instalación • Support d'Installation

Personal Assistance, Product Specs, & "How-to" Questions:

Asistencia personal, especificaciones del producto y preguntas sobre "cómo hacerlo":

Aide personnelle, spécifications du produit et questions « pratico-pratiques » :

1-800-PFAUCET (732-8238)
pfisterfaucets.com/support

Installation Videos Available
Videos de instalación a disposición
Vidéos d'installation disponibles



pfisterfaucets.com/videos

▲ WARNING / AVERTENCIA / AVERTISSEMENT

To reduce the risk of injury or property damage, read all instructions before installing product. Wear safety goggles. Product must be installed in accordance with all state & local plumbing & building codes. Call a professional if you are uncertain about installing this product.

This product has been designed for use with the Pfister™ OX6-05 or OX6-15 Roman Tub series rough-in. It will not work with any other product. For optimum performance of your roman tub, a minimum water pressure of 25 PSI (172 kPa) is recommended.

Para disminuir el riesgo de lesiones o daños a la propiedad, lea todas las instrucciones antes de instalar el producto. Utilice gafas de seguridad. El producto deberá instalarse de acuerdo con la normativa de plomería y construcción estatal y local. Llame a un profesional si no está seguro sobre cómo instalar este producto. Este producto ha sido diseñado para uso con la tubería empotrada para bañera romana OX6-05 o OX6-15 de Pfister™. No trabajará con ningún otro producto. Para un desempeño óptimo de su bañera romana, se recomienda una presión de agua mínima de 25 PSI (172 kPa).

Pour réduire le risque de blessures ou de dommages, lire toutes les instructions avant d'installer l'appareil. Porter des lunettes de sécurité. Il faut installer l'appareil en respectant tous les codes de construction et de plomberie locaux et d'État. Appelez un professionnel si vous n'êtes pas certain de la façon d'installer cet appareil. Cet appareil a été conçu pour utiliser avec la plomberie brute Pfister série OX6-05 ou OX6-15 baignoire romaine. Il ne fonctionnera pas avec un autre appareil. Pour obtenir la performance optimale de votre baignoire romaine, une pression d'eau minimale de 25 PSI (172 kPa) est recommandée.

Required Tools

Herramientas necesarias
Outils nécessaires

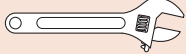

Adjustable Wrench
Llave ajustable
Clé réglable



Safety Goggles
Gafas de seguridad
Lunettes de sûreté

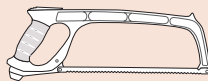

Hacksaw
Sierra Para Metales
Scie à Métaux



Plumber's Putty
Masilla para plomería
Mastic de plombier



Flashlight
Linterna
Lampe-torche



Cloth
Paño de limpieza
Chiffon

Parts in the Box • Piezas en la caja • Pièces dans la boîte

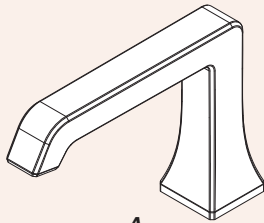

A



B (x2)



C (x2)



D



E (x2)



F



G

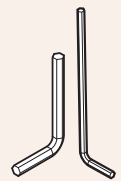

Hex Wrenches
Llaves hexagonal
Clés hexagonale

1 Turn Off Water Supply • Cierre el suministro de agua • Couper l'alimentation en eau



Locate the water supply inlets & shut off the water supply valves. These are usually found near the water meter. If you are replacing an existing unit, remove the old unit & clean mounting surface thoroughly.

Ubique las entradas del suministro de agua y cierre las válvulas de suministro. Estas se encuentran generalmente cerca del medidor de agua. Si reemplaza una unidad existente, retirela y limpie completamente la superficie de montaje.

Repérez les entrées d'alimentation d'eau et fermez les robinets d'arrêt. Ils sont normalement trouvés près du compteur d'eau. Si vous remplacez un appareil existant, enlevez le vieil appareil et nettoyez soigneusement la surface de montage.

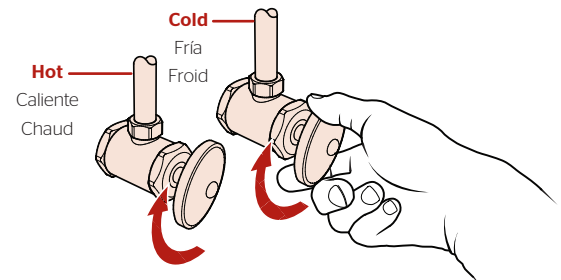

2 Prepare Rough-In & Set Up Stem Rotation

Prepare la tubería empotrada y configure la rotación del vástago

Préparez la plomberie brute et réglez la rotation

Spout Gap Dimensions

Dimensiones del espacio del conducto

Dimensions de espace de bec

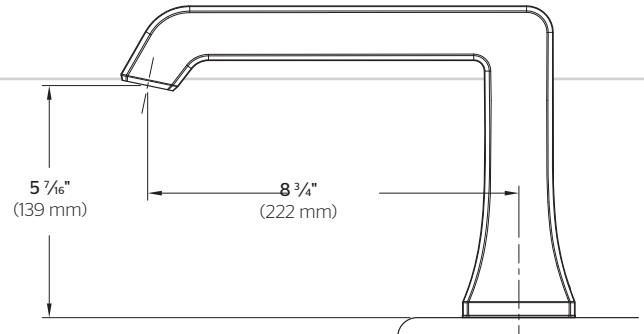

2A

Thin Surface Installation (1 3/8" Max)

Instalación de una superficie delgada (35 mm)

Installation sur une surface mince (35 mm)

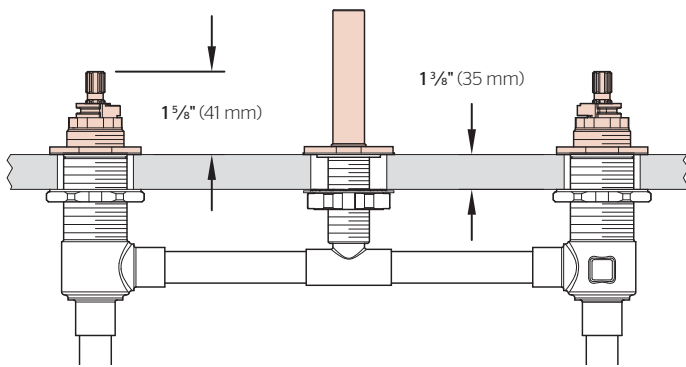

Thick Surface Installation (1 3/8" - 2 3/4" Max)

Instalación de una superficie gruesa (41 mm - 70 mm)

Installation sur une surface épaisse (41 mm - 70 mm)

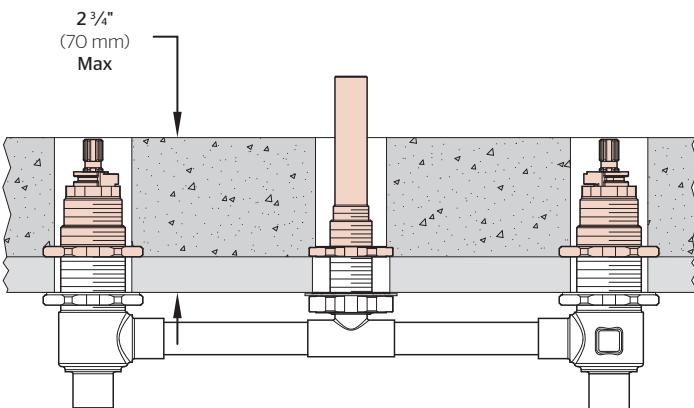

If deck thickness exceeds 1 3/8" (35 mm), Pfister™ Stem Extension Kit 974-375 must be used.

Si el grosor de la plataforma excede 1 3/8 pulg. (35 mm), se debe utilizar un juego de extensión del vástago 974-375 de Pfister™.

Si l'épaisseur du plateau de montage dépasse 1 3/8 po. (35 mm), il est nécessaire d'utiliser un kit de prolongement de tiges Pfister™ 974-375.

2B

Stem Rotation Set Up

Determinación de la rotación de las espigas

Rotation de la tige

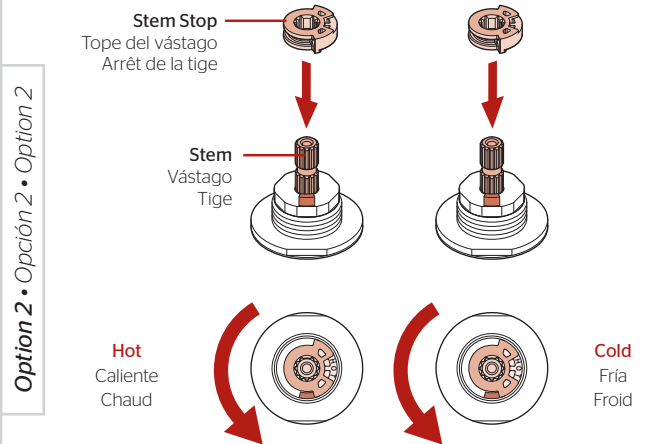
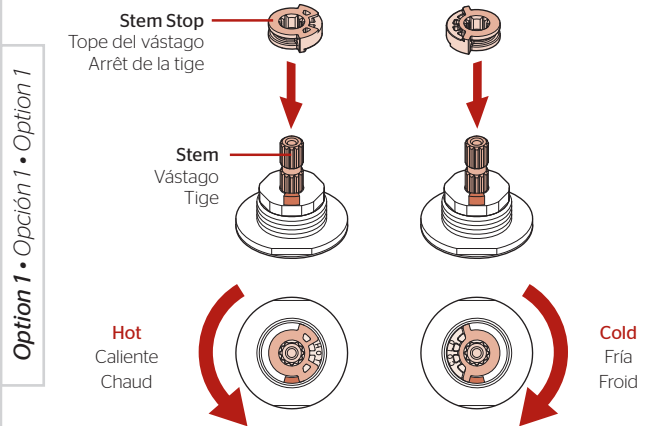

Stem Stop can be inserted into Stem in either of two ways, depending on the rotation you want to have for your handles.

El tope de la espiga puede ser insertado en la espiga en dos posiciones, dependiendo de la rotación que se quiera tener en los puños.

L'Arrêt De La Tige peut être introduit dans la tige de deux façons, selon la rotation que l'on veut obtenir pour les leviers.

3

Install Handles & Spout

Instale las manijas y el surtidor

Installez les poignées et le bec

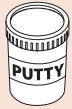

Plumber's Putty
Masilla para plomería
Mastic de plombier

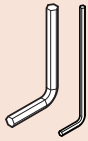

Hex Wrenches
Llaves hexagonal
Clés hexagonale



Adjustable Wrench
Llave ajustable
Clé réglable



Hacksaw
Sierra Para Metales
Scie à Métaux

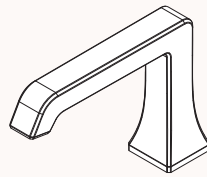

A



B (x2)



C (x2)



D



E (x2)



F



G

3A



Chamfer and deburr

Chafán y desbarbar
Chanfrein et ébarber



1 1/2" (38 mm)

HOT
CALIENTE
CHAUD

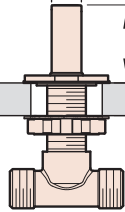
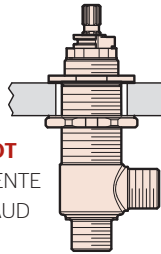

COLD
FRÍA
FROID

3B

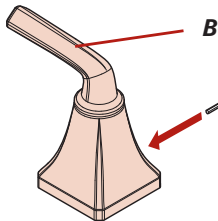

B

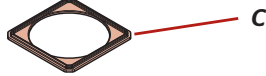

C



E

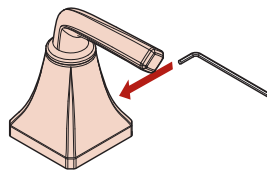

Apply Plumber's Putty in highlighted grooves beneath C (x2) & D. If installing on marble, no putty needed.

Aplique masilla de plomero en los surcos destacados debajo de C (x2) y D. Si instala en mármol, no es necesario aplicar masilla.

Appliquez le mastic de plombier dans les rainures soulignées sous C (x2) et D. Le mastic n'est pas nécessaire si vous installez sur du marbre.



3C

Use Hex Wrench to tighten set screw behind A.

Utilice una llave hexagonal para apretar lo tornillo de fijación detrás de A.

Utilisez une clef hexagonale pour serrer le vis derrière A.

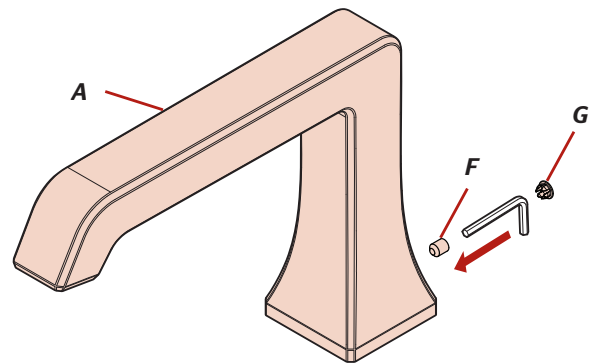

A

F

G

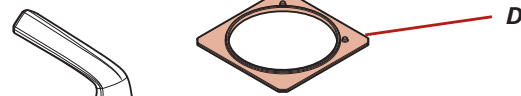

D



Refer to OX6/JX6 Installation Instructions for correct placement of valves.

Refiérase a las instrucciones de instalación OX6/JX6 para la correcta colocación de las válvulas.

Voir les instructions d'installation OX6/JX6 pour l'emplacement correct des valves.

4 Turn On Water & Confirm Proper Installation

Active el suministro de agua y confirme que la instalación está adecuadamente efectuada
Ouvrez l'eau et confirmez que l'installation est adéquate

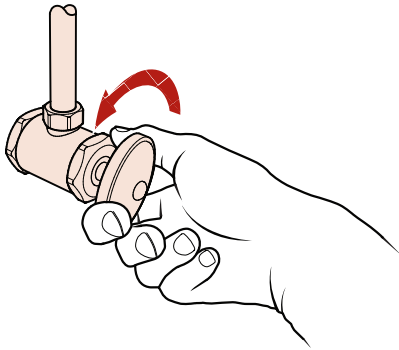

Check for leaks above and below the tub.

Revise si hay fugas encima y debajo de la tina.

Assurez-vous qu'il n'y a pas de fuite au dessus ou au dessous de la baignoire.

For Additional Installation Help:

Para la instalación adicionales de ayuda:

Pour les aides supplémentaires à l'installation:

Pfister[®]

1-800-PFAUCET (732-8238)
pfisterfaucets.com